



Totally Focused. Totally Independent.

Technical Guide

EC038/4 A

The world's largest
independent producer of
alternators 1 – 5,000kVA

Standards

Alternators are designed and produced within an ISO 9001 environment. The entire series is manufactured according to, and complies with, the most common specifications such as CEI 2-3, IEC 34-1, EN 60034-1, VDE 0530, BS 4999-5000, NF 51.111, CAN/CSA-C22.2 No14-95-No100-95, NEMA MG 1-2011, ISO 8528-3. Other standards such as UL1446, UL 1004/4 and /B are available on request.

Windings and Performances

All windings are 2/3rds pitch to eliminate triplen harmonics within the voltage waveform and to avoid excessive neutral currents in certain parallel operating conditions. A fully interconnected aluminium or copper damper cage is supplied on the rotor of all models (excluding the ECP3 series).

- ▶ 12 wire reconnectable:
 - 50Hz – 380V to 440V and 220/110V to 240/120V (de-rates may apply at certain voltages)
 - 60Hz – 380V to 480V and 220/110V to 240/120V (de-rates may apply at certain voltages)
- ▶ 6 wire reconnectable:
 - 50Hz – 380V to 440V and 220V to 240V (de-rates may apply at certain voltages)
 - 60Hz – 380V to 480V and 220V to 240V (de-rates may apply at certain voltages)

Winding Configurations	Standard		Special (dedicated)			
	12 wire Reconnectable	6 wire Reconnectable	380V and 600V 60Hz	690V 50/60Hz	220-240V 1ph 50Hz	220-240V 1ph 60Hz
ECP3 to ECO38	Std	Option	Option	Option	Option	Option
ECO40 to ECO46	Std	Option	Option	Option	Option (to ECO40)	Option (to ECO40)
Insulation materials	Class H	Class H	Class H	Class H	Class H	Class H
High efficiency	Std	Std	Std	Std	Std	Std
High motor starting	>300%	>300%	>300%	>300%	>300%	>300%
THD (Total Harmonic Distortion)	Typically <3.5% full load L-L	Typically <3.0% full load L-L	Typically <3.5% full load L-L	Typically <3.5% full load L-L	Typically <4.5% full load L-N	Typically <4.5% full load L-N
Interference suppression	VDE 0875 G/N/K, EN61000-6-3, EN61000-6-2, others available on request					

Winding Protection

There are various degrees of protection for the windings following the standard impregnation process, as can be seen here. The TOTAL or TOTAL+ butadienic black flexible coating is recommended for arduous applications.

Winding Protection:	STANDARD	STANDARD+	GREY	TOTAL (3% de-rate may apply on certain models)	TOTAL+ (3% de-rate may apply on certain models)
ECP3	Std	Option	Option	Option	Option
ECP28, NPE32 and ECP32	-	Std	Option	Option	Option
ECP34 to ECO46	-	-	Std	Option	Option

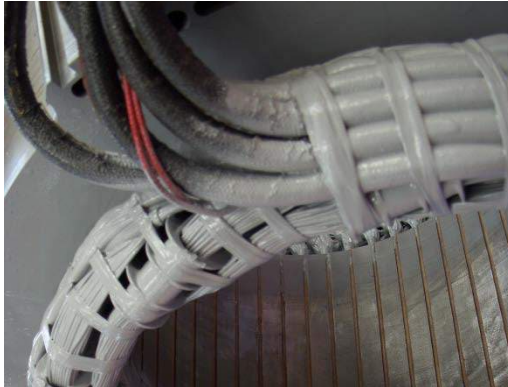

Grey treatment (marinization) on the left, TOTAL treatment shown on the right. The EG43 grey varnish, is an high temperature insulating enamel that forms a tough and flexible film, with excellent moisture and chemical protection. It is water and oil proof, and also protects windings from abrasion. It is applied spraying an over coating layer over the impregnated winding, or dipping the stator in a varnish barrel for superior treatments

The TOTAL is a protection system that makes Mecc Alte special. It is the ultimate winding treatment that offers truly superior performances when the environment is really harsh, or the application very demanding. It is a rubbery protection treatment, used to replace epoxies and silicones winding encapsulation. The TOTAL flexible black compound cures to a tough, resilient, glossy black thick coating that seals the copper against moisture and chemical attacks. Due to its encapsulation capability and flexibility, is also extremely resistant to the particle abrasion as it adsorbs the impacts. Moreover, the high flexibility leads to a long-trouble less life protection, as the compound follows elastically the thermal expansion cycles of the windings from the cold to the hot condition and vice versa without forming any cracks.

Protection for Environment

In addition to protection on the windings themselves, the alternators can have increased ingress protection. Standard levels are IP23 with further upgrades available to include inlet filters, IP43 and IP45: 7% de-rates apply on inlet filters and IP43 protection. 20-30% de-rates apply for IP45 depending on alternator model.

Additional air exit louvres (called IP23+) are optionably retrofittable in the overall ECP32 to ECO 46 range, in order to comply to the most strict marine regulations.



Construction

The robust mechanical structure withstands up to 5G in any direction and 9G vertically and its design permits easy access to the connections and components during routine maintenance check-ups. The mechanical design has used the most advanced FEM techniques. The materials used are: FEPI2 steel for the frame, C45 steel for the shaft and cast iron or aluminum pressure die cast for the end-brackets: fans are aluminum die casted either nylon fiber glass loaded, UL compliant materials. Rotors are dynamically balanced according grade 2.5 of ISO 1940-1.

Terminals and Terminal Box

Easy access to regulators is assured through a pull out drawer or a drop down panel to allow safer adjustment. Large terminal boxes allow easy access of power cables, in the ECO43 and ECO46 higher power ranges the terminal allow the convenient choice of power cable or busbar connection with versatility of entry and connection. Current transformers are available as an option on series ECO 40, 43 and 46 with single or dual output.

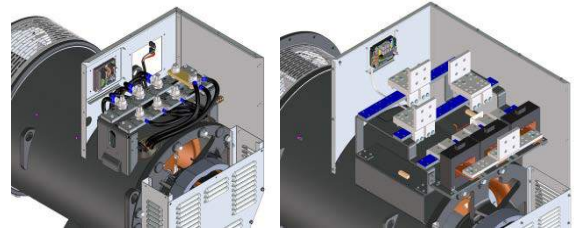

Excitation and Regulation Systems

All ECP/ECO series have MAUX auxiliary winding to power the digital regulator. Both DSR and the DER1 are available to connect to PC through the DxR2 USB interface and DxR TERMINAL software to interrogate/download alarms & settings for analysis or for cloning other regulators. DER2 has got an integrated USB connection and can be connected to the PC without any optional connection boards. More settings such as LAMS, digital RAM based synchronous external control and soft start are obtainable through the DxR connection. Simple analogue potentiometers are available for the more usual adjustments.

Excitation Systems	DSR	DER1	DER2
ECP3 to ECO38	Std	Option	Option
ECO40 to ECO46	-	Std	Option
Parallel Operation	√	√	√
Mains Parallel	√	√	√
3 Phase Sensing (rms)	-	√	√
Accuracy	+/-1%	+/-0.5%	+/-0.5%
Remote Voltage Control	√	√	√
Alarm Log	√	√	√
Analogue and Digital Configurable	√	√	√
LAMS (Load Acceptance V/f)	√	√	√
APO (Active Protection Output)	√	√	√
Soft Start	√	√	√
High dynamic response	-	-	√
USB connection without external boards	-	-	√

For a given motor start duty a smaller machine may be selected – also enhanced by low sub-transient reactance values for non-linear loads. The whole range from 6.5 to 3400kVA is capable of >300% sustained short circuit current for up to 20 seconds.

Optional PMG3

PMG3 can be retro fit or factory fit on ECO 40, 43 and 46 series. This smart MeccAlte design allows an easy fix kit, through a tapered cone coupling and a simple replacement of the rear air louvre. PMG3 is also available on ECO 38, when ordered from the factory.

The complete AVR range is fully compatible with both MAUX and PMG3 systems, this minimises spare part management and flexibility of stock as one AVR suits all applications. The PMG3 is delivering the same amount of kVA available with the MAUX.

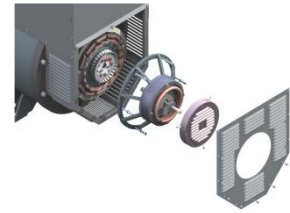

Accessories

Additional optionals can be fit on our alternator series, such as PTC thermistors or PT100 both on windings and bearings, space heaters, high and low profile of terminal boxes (on most series), air filter clogging sensors, rotating diode bridge failure sensor (RBD), power factor controller for parallel operation (PFR/2), parallel devices (standard from ECO 40), air filters, IP43 and IP45 protections, marine IP23 + protection for SOLAS requirements and many others.

Deration coefficients

Altitude (meters)	Ambient temperature (Celsius)					
	25	40	45	50	55	60
≤ 1000	1.07	1	0.96	0.93	0.91	0.89
$> 1000 \leq 1500$	1.01	0.96	0.92	0.89	0.87	0.84
$> 1500 \leq 2000$	0.96	0.91	0.87	0.84	0.83	0.79
$> 2000 \leq 3000$	0.9	0.85	0.81	0.78	0.76	0.73

Notes on short circuit curves

The indicated coefficients have to be used to correct the three phase short circuit curves values as a function of the rated voltage.

The indicated coefficient have to be used to correct the three phase short circuit curves values as a function of the type of short circuit voltage.

50 Hz		60 Hz	
Voltage	Factor	Voltage	Factor
380	0.93X	415	0.85X
400	1X	440	0.90X
415	1.04X	460	0.95X
440	1.10X	480	1X

	3 phase	2 phase L-L	1 phase L-N
<i>Istantaneous</i>	1X	0.87X	1.30X
<i>Minimum</i>	1X	1.80X	3.20X
<i>Sustained</i>	1X	1.50X	2.50X
<i>Max Duration</i>	20 sec.	10 sec.	4 sec.

All the curves are shown for series or parallel star connection at 400V 50 Hz or 480V 60 Hz. If the unit is reconnected from series to parallel star, the additional coefficient is 2X. From series star to series delta, it is 1.72X. From series star to parallel delta, it is 3.44X.

General Characteristics

Pole number	4	Insulation class	H
Phase Number	3	Protection class	IP23
Number of wires	12	NDE bearing	6314.2RS
Execution	Brushless	DE bearing	6318.2RS
Regulator type	DSR	Maximum overspeed	2250
Winding pitch	2/3	Altitude	0-1000
Winding code	T04055	Balancing	ISO1940-1

Ratings 50Hz

kVA / kW @ Temp. Rise / Ambient °C - 0.8 PF

	STANDBY-163/27				STANDBY-150/40				H-125/40				F-105/40				B-80/40				
Series	380V	400V	415V	440V	380V	400V	415V	440V	380V	400V	415V	440V	380V	400V	415V	440V	380V	400V	415V	440V	
Parallel Star YY	190V	200V	208V	220V	190V	200V	208V	220V	190V	200V	208V	220V	190V	200V	208V	220V	190V	200V	208V	220V	
Series Delta Δ	220V	230V	240V	245V	220V	230V	240V	245V	220V	230V	240V	245V	220V	230V	240V	245V	220V	230V	240V	245V	
Parallel Delta ΔΔ	110V	115V	120V	127V	110V	115V	120V	127V	110V	115V	120V	127V	110V	115V	120V	127V	110V	115V	120V	127V	
ECO38-15/4 A	kVA	196	196	196	180	188	188	188	173	180	180	180	165	170	170	170	155	144	144	144	132
	kW	157	157	157	144	150	150	150	138	144	144	144	132	136	136	136	124	115	115	115	106
ECO38-25/4 A	kVA	220	220	220	209	211	211	211	200	200	200	200	190	185	185	185	175	160	160	160	152
	kW	176	176	176	167	169	169	169	160	160	160	160	152	148	148	148	140	128	128	128	122
ECO38-35/4 A	kVA	250	250	250	234	237	237	237	221	225	225	225	210	207	207	207	190	180	180	180	168
	kW	200	200	200	187	190	190	190	177	180	180	180	168	166	166	165	152	144	144	144	134
ECO38-1L/4 A	kVA	275	275	275	253	264	264	264	243	250	250	250	230	230	230	230	215	200	200	200	184
	kW	220	220	220	202	211	211	211	194	200	200	200	184	184	184	184	172	160	160	160	147
ECO38-2L/4 A	kVA	330	330	330	319	315	315	315	305	300	300	300	290	275	275	275	265	240	240	240	232
	kW	264	264	264	255	252	252	252	244	240	240	240	232	220	220	220	212	192	192	192	186
ECO38-3L/4 A	kVA	370	370	370	360	360	360	360	350	350	350	350	340	320	320	320	310	280	280	280	272
	kW	296	296	296	288	288	288	288	280	280	280	280	272	256	256	256	248	224	224	224	218

Ratings 60Hz

kVA / kW @ Temp. Rise / Ambient °C - 0.8 PF

	STANDBY-163/27				STANDBY-150/40				H-125/40				F-105/40				B-80/40				
Series	415V	440V	460V	480V	415V	440V	460V	480V	415V	440V	460V	480V	415V	440V	460V	480V	415V	440V	460V	480V	
Parallel Star YY	208V	220V	230V	240V	208V	220V	230V	240V	208V	220V	230V	240V	208V	220V	230V	240V	208V	220V	230V	240V	
Series Delta Δ	240V	254V	265V	277V	240V	254V	265V	277V	240V	254V	265V	277V	240V	254V	265V	277V	240V	254V	265V	277V	
Parallel Delta ΔΔ	120V	127V	133V	138V	120V	127V	133V	138V	120V	127V	133V	138V	120V	127V	133V	138V	120V	127V	133V	138V	
ECO38-15/4 A	kVA	225	236	236	236	220	230	230	230	210	220	220	220	195	205	205	205	168	176	176	176
	kW	180	189	189	189	176	184	184	184	168	176	176	176	156	164	164	164	134	141	141	141
ECO38-25/4 A	kVA	253	264	264	264	242	253	253	253	230	240	240	240	210	220	220	220	184	192	192	192
	kW	202	211	211	211	194	202	202	202	184	192	192	192	168	176	176	176	147	154	154	154
ECO38-35/4 A	kVA	289	300	300	300	274	284	284	284	260	270	270	270	240	250	250	250	208	216	216	216
	kW	231	240	240	240	219	227	227	227	208	216	216	216	192	200	200	200	166	173	173	173
ECO38-1L/4 A	kVA	319	330	330	330	305	316	316	316	290	300	300	300	270	280	280	280	232	240	240	240
	kW	255	264	264	264	244	253	253	253	232	240	240	240	216	224	224	224	186	192	192	192
ECO38-2L/4 A	kVA	358	374	396	396	341	357	378	378	325	340	360	360	300	310	330	330	260	272	288	288
	kW	286	299	317	317	273	286	302	302	260	272	288	288	240	248	264	264	208	218	230	230
ECO38-3L/4 A	kVA	402	444	444	444	391	432	432	432	380	420	420	420	350	385	385	385	304	336	336	336
	kW	322	355	355	355	313	346	346	346	304	336	336	336	280	308	308	308	243	269	269	269

Reactance & Time constants - Class H / 400V

Unsaturated (ref. EN6000034-4)			ECO38-1S/4 A	ECO38-2S/4 A	ECO38-3S/4 A	ECO38-1L/4 A	ECO38-2L/4 A	ECO38-3L/4 A
X_d	Direct-axis synchronous reactance	%	203,9	207	198,7	214,2	215,3	222,5
X_d'	Direct-axis transient reactance	%	10	11,4	12,7	14,5	15,8	17,8
X_d''	Direct-axis subtransient reactance	%	5,69	6,11	6,72	7,45	8,38	9,73
X_q	Quadrature-axis synchronous reactance	%	100,3	113,8	109,7	121,1	124,2	130,4
X_q'	Quadrature-axis transient reactance	%	100,3	113,8	109,7	121,1	124,2	130,4
X_q''	Quadrature-axis subtransient reactance	%	20,4	22,2	23	22,8	21,5	20,8
X₂	Negative-sequence reactance	%	13,2	14,8	15,9	16,6	16,7	16,2
X₀	Zero sequence reactance	%	2,79	2,59	2,69	2,48	2,38	2,28
Saturated								
X_d	Direct-axis synchronous reactance	%	169,2	171,8	164,9	177,8	178,7	184,7
X_d'	Direct-axis transient reactance	%	8,33	9,45	10,5	12	13,1	14,8
X_d''	Direct-axis subtransient reactance	%	4,72	5,07	5,58	6,19	6,96	8,08
X_q	Quadrature-axis synchronous reactance	%	83,2	94,5	91	100,5	103,1	108,2
X_q'	Quadrature-axis transient reactance	%	83,2	94,5	91	100,5	103,1	108,2
X_q''	Quadrature-axis subtransient reactance	%	16,9	18,5	19,1	18,9	17,9	17,3
X₂	Negative-sequence reactance	%	11	12,3	13,2	13,7	13,8	13,5
X₀	Zero sequence reactance	%	2,79	2,59	2,69	2,48	2,38	2,28
K_{cc}	Short circuit ratio		0,44	0,46	0,45	0,44	0,43	0,42
T_d'	Transient time constant	sec	0,073	0,078	0,083	0,085	0,091	0,099
T_d''	Subtransient time constant	sec	0,011	0,012	0,013	0,013	0,012	0,013
T_{do}	Open circuit time constant	sec	0,7	0,9	1,1	1,3	1,4	1,5
T_a	Armature time constant	sec	0,015	0,016	0,018	0,017	0,016	0,013

Additional information - Class H / 400V

I_o	Excitation current at no load	A	0,7	0,7	0,67	0,71	0,78	0,72
I_c	Excitation current at full load	A	3,1	3,0	3,0	2,8	3,9	3,9
Overload long-term			1 hour in a 6 hours period 110% rated load					
Overload per 20 sec.		%	300,0					
Heat dissipation		W	11844	12600	13548	14133	16137	19465
Telephone Interference (THF)			<2	<2	<2	<2	<2	<2
Waveform Distors.(THD) at full load (LL/LN)		%	3,1 / 3	3 / 2,9	2,8 / 2,9	2,9 / 3,1	3 / 2,9	3,1 / 2,9
Waveform Distors.(THD) at no load (LL/LN)		%	2,8 / 2,7	2,7 / 2,6	2,6 / 2,8	2 / 2,1	2,6 / 2,8	2,7 / 2,7

Reactance & Time constants - Class H / 480V

Unsaturated (ref. EN6000034-4)			ECO38-1S/4 A	ECO38-2S/4 A	ECO38-3S/4 A	ECO38-1L/4 A	ECO38-2L/4 A	ECO38-3L/4 A
X_d	Direct-axis synchronous reactance	%	207,7	207	198,7	214,2	215,3	222,5
X_d'	Direct-axis transient reactance	%	10,2	11,4	12,7	14,5	15,8	17,8
X_d''	Direct-axis subtransient reactance	%	5,8	6,11	6,72	7,45	8,38	9,73
X_q	Quadrature-axis synchronous reactance	%	102,1	113,8	109,7	121,1	124,2	130,4
X_q'	Quadrature-axis transient reactance	%	102,1	113,8	109,7	121,1	124,2	130,4
X_q''	Quadrature-axis subtransient reactance	%	20,8	22,2	23	22,8	21,5	20,8
X₂	Negative-sequence reactance	%	13,5	14,8	15,9	16,6	16,7	16,2
X₀	Zero sequence reactance	%	2,85	2,59	2,69	2,48	2,38	2,28
Saturated								
X_d	Direct-axis synchronous reactance	%	172,4	171,8	164,9	177,8	178,7	184,7
X_d'	Direct-axis transient reactance	%	8,49	9,45	10,5	12	13,1	14,8
X_d''	Direct-axis subtransient reactance	%	4,81	5,07	5,58	6,19	6,96	8,08
X_q	Quadrature-axis synchronous reactance	%	84,8	94,5	91	100,5	103,1	108,2
X_q'	Quadrature-axis transient reactance	%	84,8	94,5	91	100,5	103,1	108,2
X_q''	Quadrature-axis subtransient reactance	%	17,2	18,5	19,1	18,9	17,9	17,3
X₂	Negative-sequence reactance	%	11,2	12,3	13,2	13,7	13,8	13,5
X₀	Zero sequence reactance	%	2,85	2,59	2,69	2,48	2,38	2,28
K_{cc}	Short circuit ratio		0,44	0,46	0,45	0,44	0,43	0,42
T_d'	Transient time constant	sec	0,073	0,078	0,083	0,085	0,091	0,099
T_d''	Subtransient time constant	sec	0,011	0,012	0,013	0,013	0,012	0,013
T_{do}	Open circuit time constant	sec	0,7	0,9	1,1	1,3	1,4	1,5
T_a	Armature time constant	sec	0,015	0,016	0,018	0,017	0,016	0,013

Additional information - Class H / 480V

I_o	Excitation current at no load	A	0,65	0,65	0,65	0,7	0,7	0,7
I_c	Excitation current at full load	A	3,0	2,9	2,9	2,8	3,8	3,9
Overload long-term			1 hour in a 6 hours period 110% rated load					
Overload per 20 sec.		%	300,0					
Heat dissipation		W	12437	12691	13299	13968	16118	20310
Telephone Interference (TIF)			<40	<40	<40	<40	<40	<40
Waveform Distors.(THD) at full load (LL/LN)		%	3,1 / 3	3 / 2,9	2,8 / 2,9	2,9 / 3,1	3 / 2,9	3,1 / 2,9
Waveform Distors.(THD) at no load (LL/LN)		%	2,8 / 2,7	2,7 / 2,6	2,6 / 2,8	2 / 2,1	2,6 / 2,8	2,7 / 2,7

Efficiencies @ 50Hz

Models		380V 50Hz					400V 50Hz					415V 50Hz					440V 50Hz				
		0.25	0.5	0.75	1	1.1	0.25	0.5	0.75	1	1.1	0.25	0.5	0.75	1	1.1	0.25	0.5	0.75	1	1.1
ECO38-1S/4 A	%	89,1	91,2	92,3	92,3	92,1	88,9	91,3	92,6	92,4	92,1	88,7	91,3	92,5	92,1	91,8	88,5	91,1	92,2	91,9	91,5
ECO38-2S/4 A	%	90,1	91,6	92,6	92,6	92,4	89,9	91,7	92,9	92,7	92,4	89,7	91,7	92,8	92,4	92,1	89,5	91,5	92,5	92,2	91,8
ECO38-3S/4 A	%	89,6	91,9	93,0	92,9	92,7	89,4	92,0	93,3	93,0	92,7	89,2	92,0	93,2	92,7	92,4	89,0	91,8	92,9	92,5	92,1
ECO38-1L/4 A	%	90,1	92,3	93,4	93,3	93,1	89,9	92,4	93,7	93,4	93,1	89,7	92,4	93,6	93,1	92,8	89,5	92,2	93,3	92,9	92,5
ECO38-2L/4 A	%	90,2	92,7	93,8	93,5	93,3	89,9	92,7	94,0	93,7	93,4	89,7	92,7	93,9	93,4	93,1	89,5	92,5	93,6	93,2	92,8
ECO38-3L/4 A	%	90,1	92,5	93,4	93,4	93,2	89,9	92,6	93,7	93,5	93,2	89,7	92,6	93,6	93,2	92,9	89,5	92,4	93,3	93,0	92,6

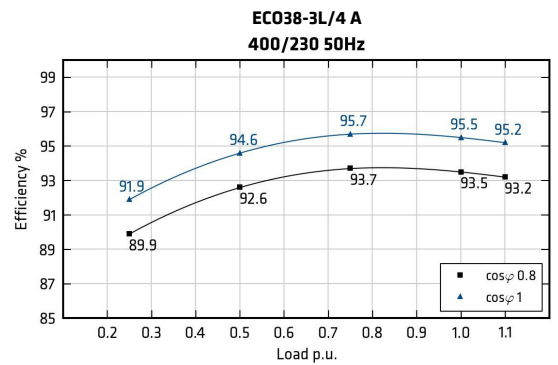
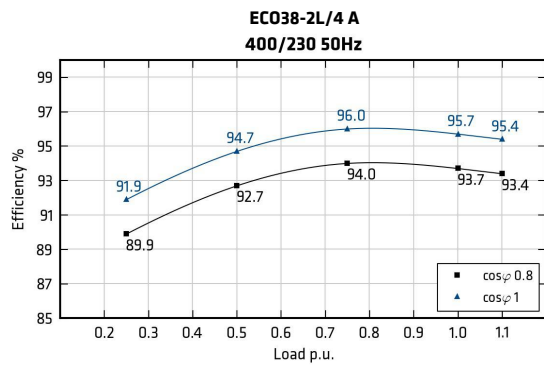
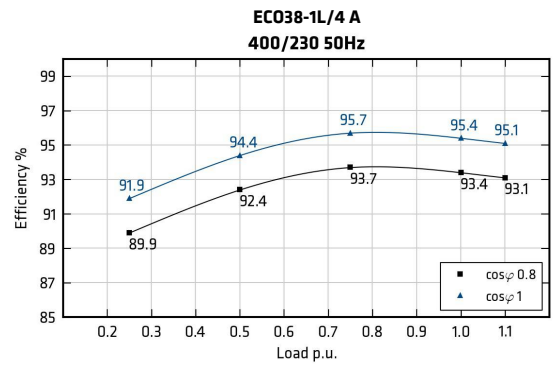
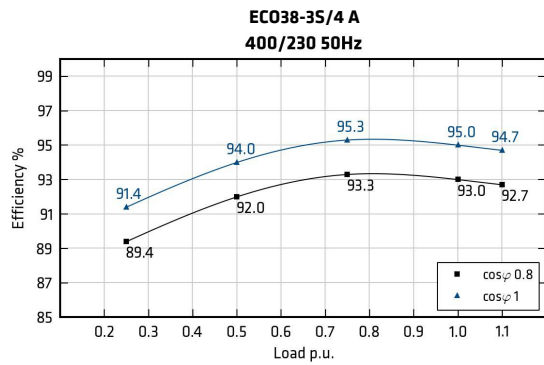
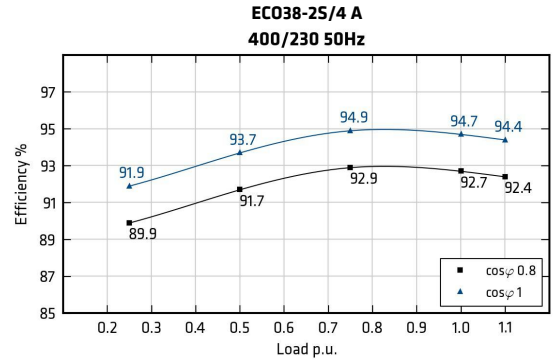
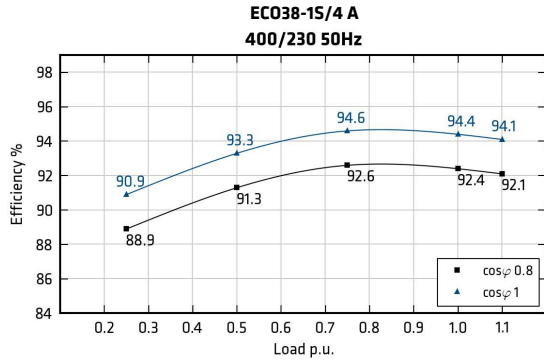

Efficiencies @ 60Hz

Models		415V 60Hz					440V 60Hz					460V 60Hz					480V 60Hz				
		0.25	0.5	0.75	1	1.1	0.25	0.5	0.75	1	1.1	0.25	0.5	0.75	1	1.1	0.25	0.5	0.75	1	1.1
ECO38-1S/4 A	%	90,1	92,0	93,0	92,7	92,4	90,1	92,1	93,2	93,2	93,0	90,1	92,2	93,4	93,3	93,2	89,9	92,3	93,6	93,4	93,2
ECO38-2S/4 A	%	90,6	92,5	93,4	93,1	92,8	90,6	92,6	93,6	93,6	93,4	90,6	92,7	93,8	93,7	93,6	90,4	92,8	94,0	93,8	93,6
ECO38-3S/4 A	%	90,6	93,1	93,9	93,5	93,2	90,6	93,2	94,1	94,0	93,8	90,6	93,3	94,3	94,1	94,0	90,4	93,4	94,5	94,2	94,0
ECO38-1L/4 A	%	90,6	93,4	94,3	93,8	93,5	90,6	93,5	94,5	94,3	94,1	90,6	93,6	94,7	94,4	94,2	90,4	93,7	94,9	94,5	94,1
ECO38-2L/4 A	%	90,6	93,6	94,5	94,0	93,7	90,6	93,7	94,7	94,5	94,3	90,6	93,8	94,9	94,6	94,4	90,4	93,9	95,1	94,7	94,3
ECO38-3L/4 A	%	90,6	93,0	93,9	93,6	93,3	90,6	93,1	94,1	94,1	93,9	90,6	93,2	94,3	94,2	94,0	90,4	93,3	94,5	94,3	93,9

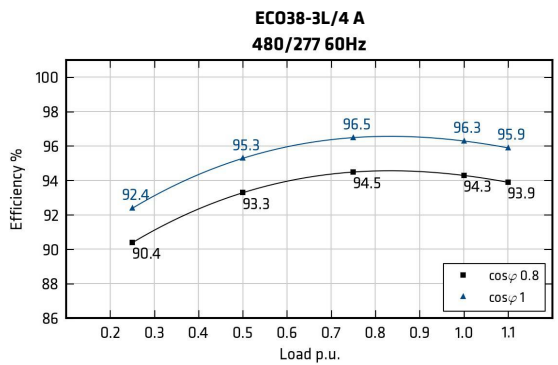
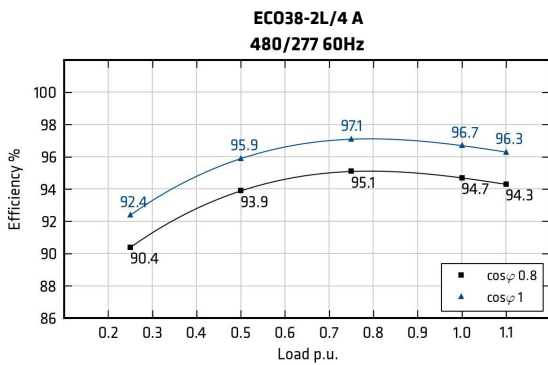
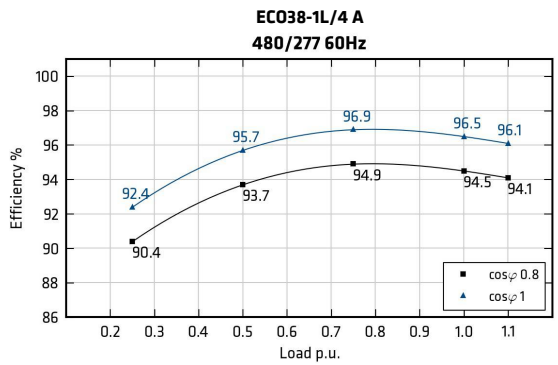
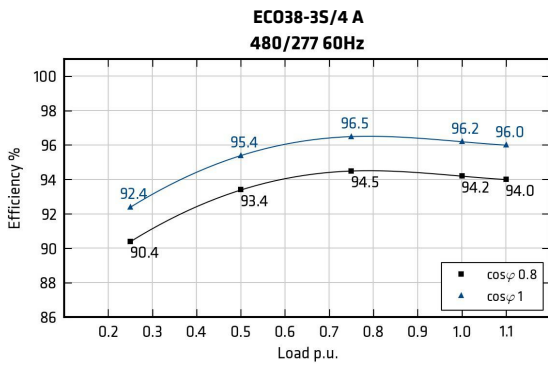
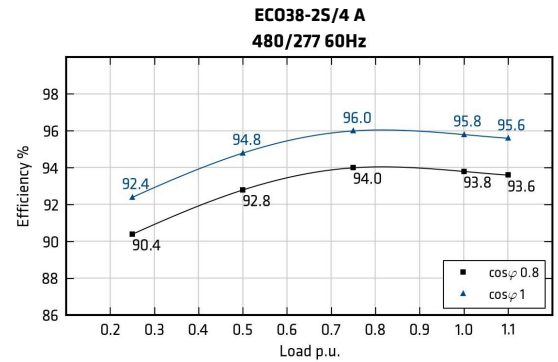
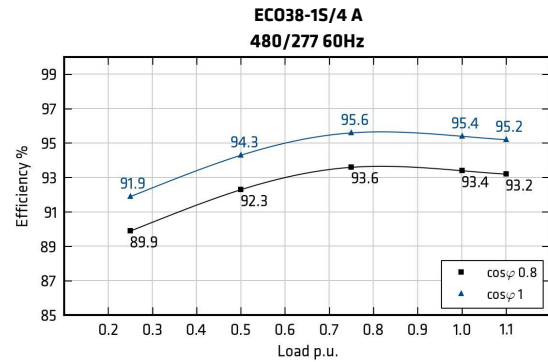

Transients voltage

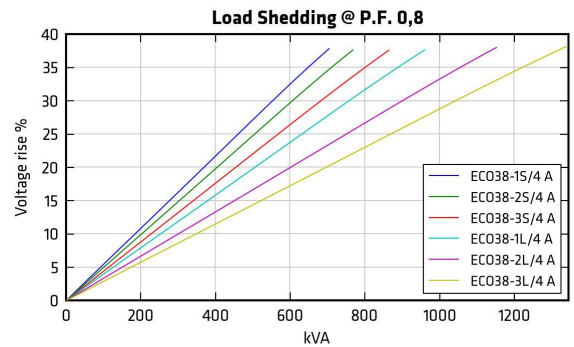
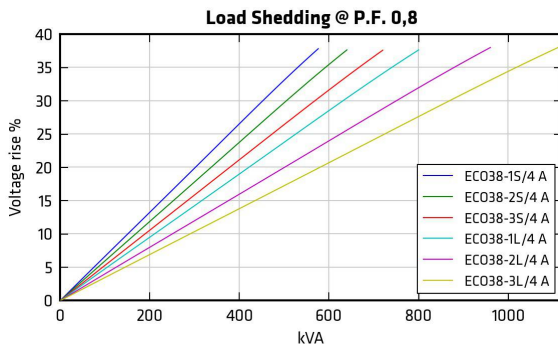
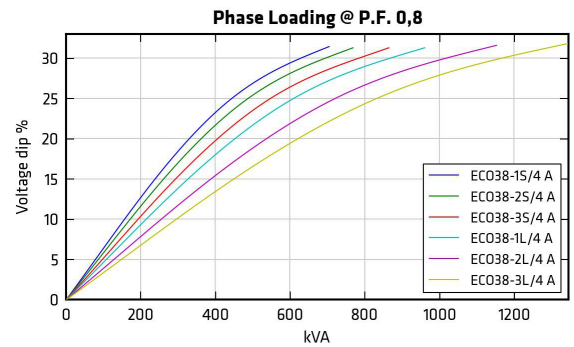
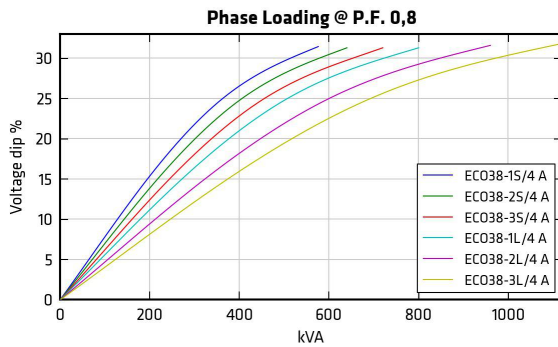
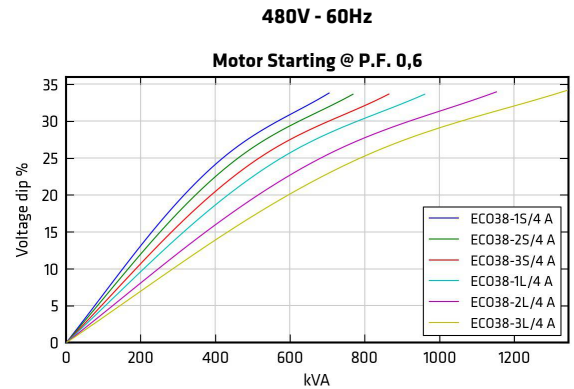
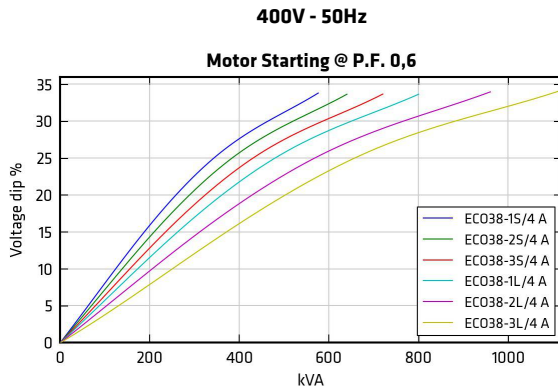

In order to scale transient curves as a function of a power factor or voltage if not indicated, please proceed as follows:

Power Factor coefficient corrector (PFCC), to be used on power factor 0.6 curves:

$$PFCC = \sin(\text{ARCCos}(PF_{\text{new}})) / 0.8$$

Example. The PFCC at power factor 0.3 is 1.192 [$PFCC = \sin(\text{ARCCos}(0.3)) / 0.8$]. This means that the voltage fall at a given power at pf 0.3 is equivalent to the one that can be read on the pf 0.6 curve if the load is considered 1.192 times bigger (19% higher value.).

In this example, a 100 kVA load insertion at pf 0.3 is equivalent in voltage fall to a 119kVA load insertion at pf 0.6.

Voltage coefficient corrector (VCC):

$$VCC = (400/V_{\text{new}})^2 \text{ if } 50 \text{ Hz}; VCC = (480/V_{\text{new}})^2 \text{ if } 60 \text{ Hz}$$

Example. VCC at 415V 60 Hz is 1.338 [$VCC = (480/415)^2$]. This means that the voltage fall at a given power at 415V is equivalent to the one that can be read on the power factor 0.6 curve if the load is considered 1.338 times bigger (33% higher value.).

In this example, a 100 kVA load insertion at 415V is equivalent in voltage fall to a 133kVA load insertion at 480V.

50Hz Short circuit decrement curves - No load excitation at rated speed

ECO38-1S/4 A

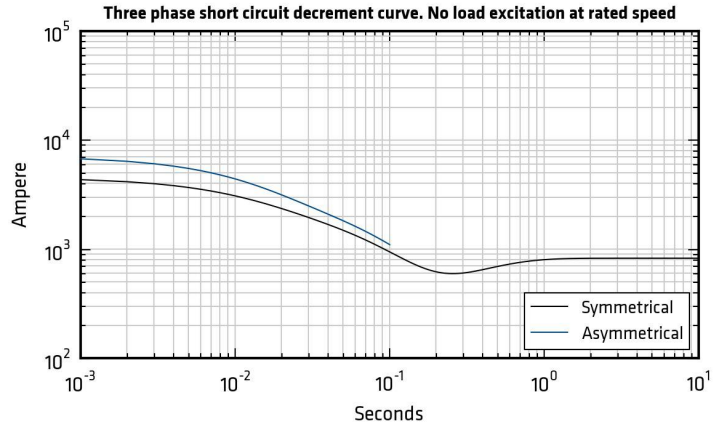

ECO38-2S/4 A

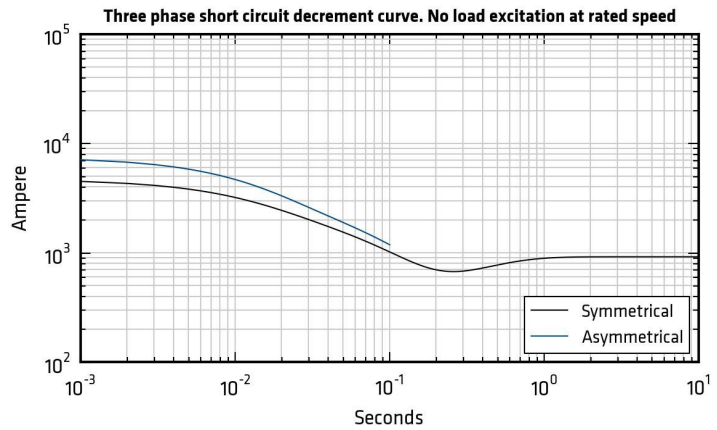

ECO38-3S/4 A

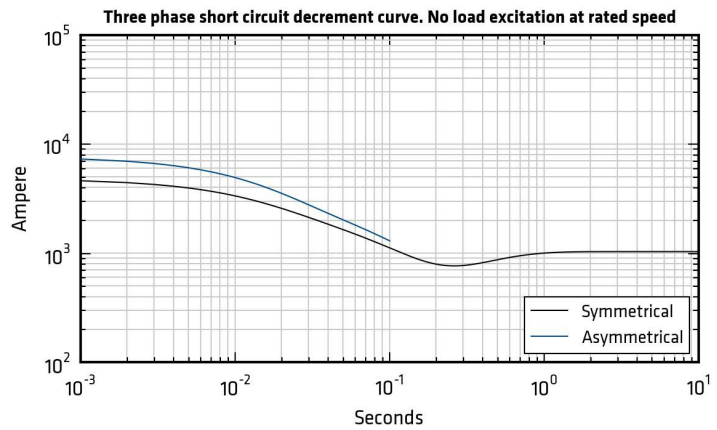

ECO38-1L/4 A

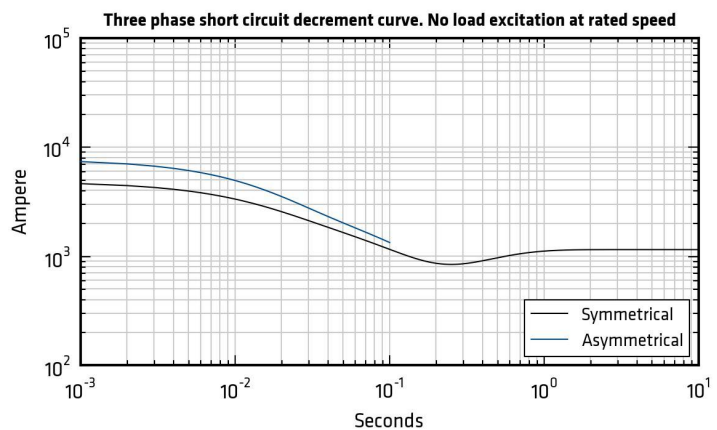

*Please refer to tables at page 6

50Hz Short circuit decrement curves - No load excitation at rated speed

ECO38-2L/4 A

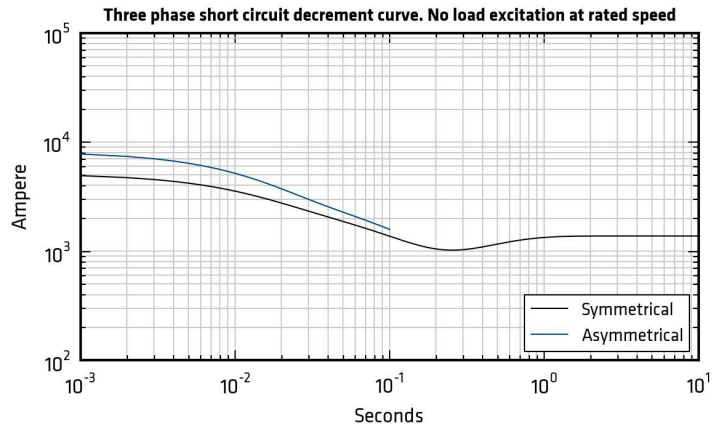

ECO38-3L/4 A

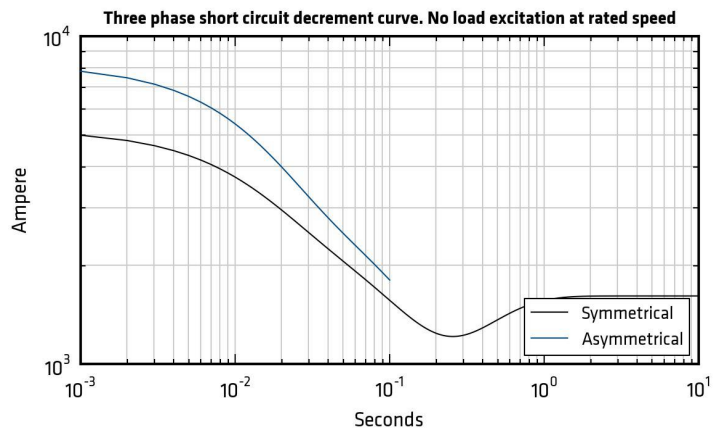

*Please refer to tables at page 6

60Hz Short circuit decrement curves - No load excitation at rated speed

ECO38-1S/4 A

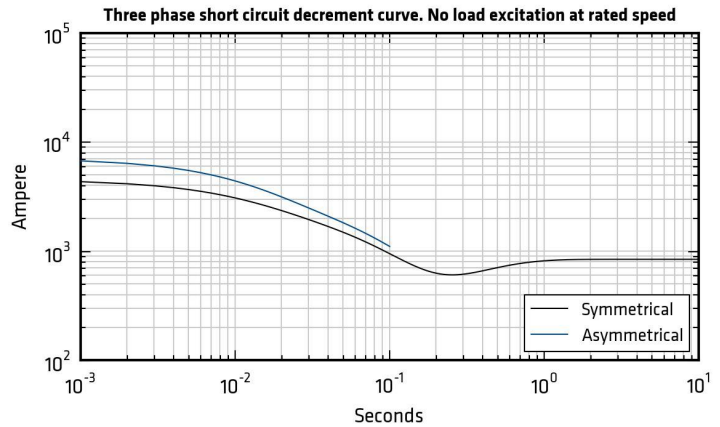

ECO38-2S/4 A

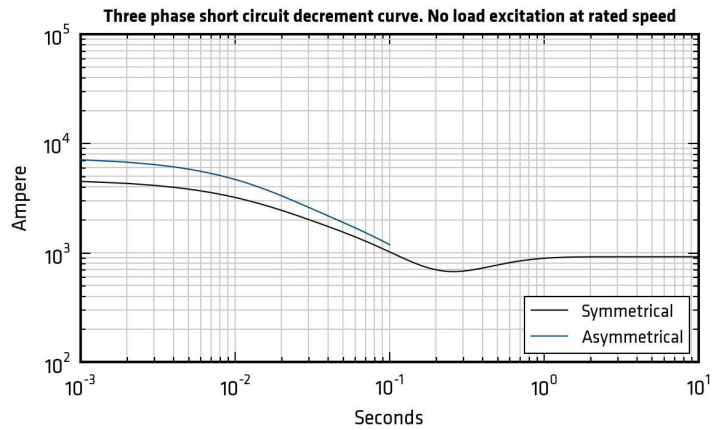

ECO38-3S/4 A

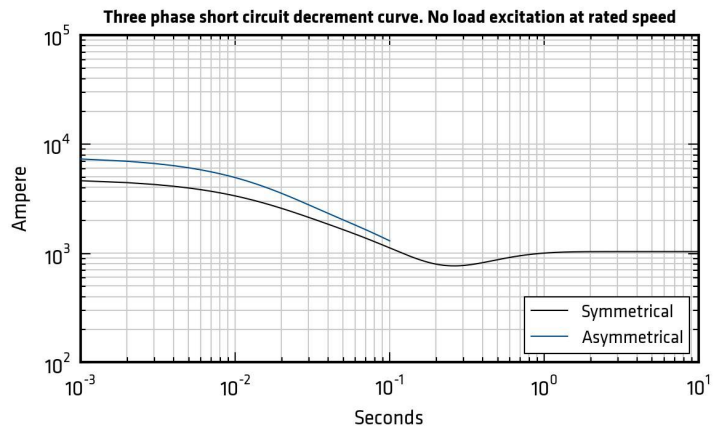

ECO38-1L/4 A

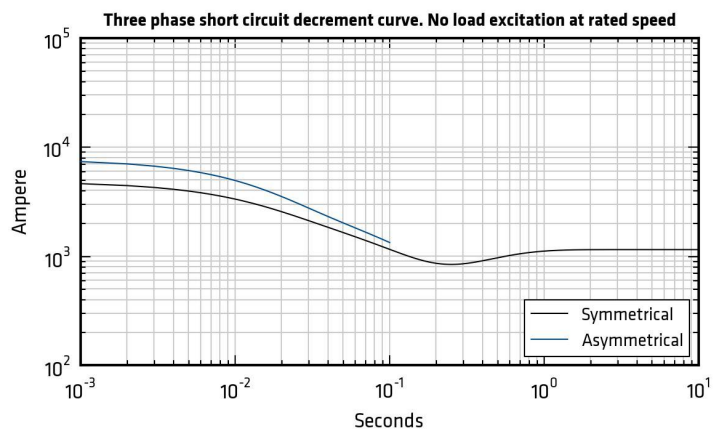

*Please refer to tables at page 6

60Hz Short circuit decrement curves - No load excitation at rated speed

ECO38-2L/4 A

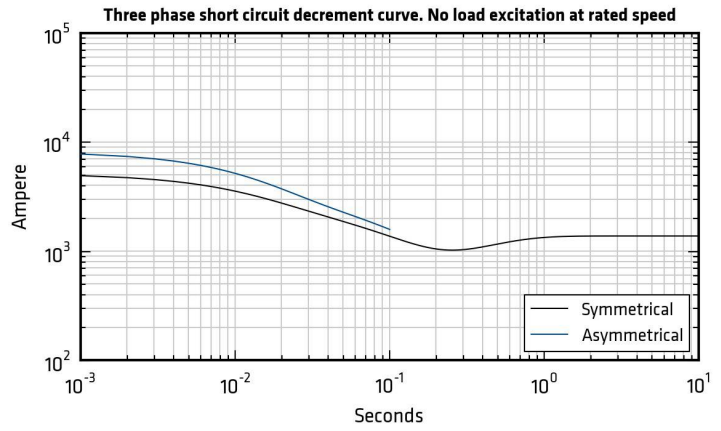

ECO38-3L/4 A

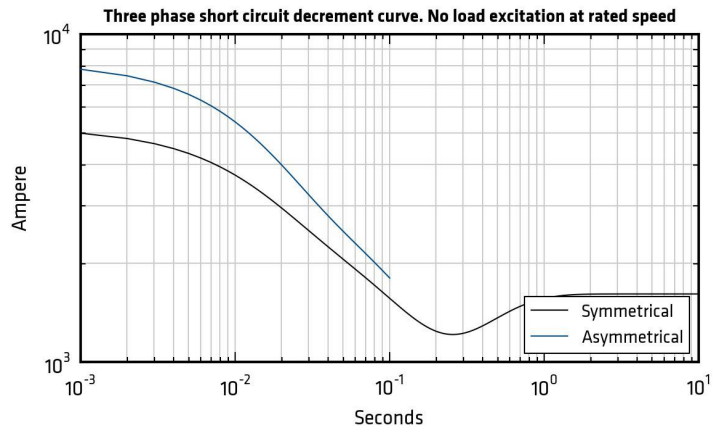

*Please refer to tables at page 6

Additional Characteristics

Data	ECO38-1S/4 A		ECO38-2S/4 A		ECO38-3S/4 A		ECO38-1L/4 A		ECO38-2L/4 A		ECO38-3L/4 A		
	50Hz	60Hz	50Hz	60Hz	50Hz	60Hz	50Hz	60Hz	50Hz	60Hz	50Hz	60Hz	
Damper cage	Copper												
Stator Winding Resistance (20°C)	Ω	0,013	0,011	0,008	0,007	0,006	0,004						
Rotor Winding Resistance (20°C)	Ω	3,905	4,133	4,449	4,887	5,604	6,78						
Stator Exciter Resistance (20°C)	Ω	15,28	15,28	15,28	15,28	15,28	15,28						
Rotor Exciter Resistance (20°C)	Ω	0,685	0,685	0,685	0,685	0,685	0,685						
Weight	Kg	510,0	560,0	590,0	680,0	765,0	905,0						
Unbalanced Magnetic pull	kN/mm	4,4	5,2	5,7	5,1	5,9	6,2						
Cooling air requirement	m3/min	32,0	39,0	32,0	39,0	32,0	39,0	32,0	39,0	32,0	39,0	32,0	39,0
Noise Level at 1m/7m	dB(A)	82/69	86/73	82/69	86/73	82/69	86/73	82/69	86/73	82/69	86/73	82/69	86/73

PQ Diagram

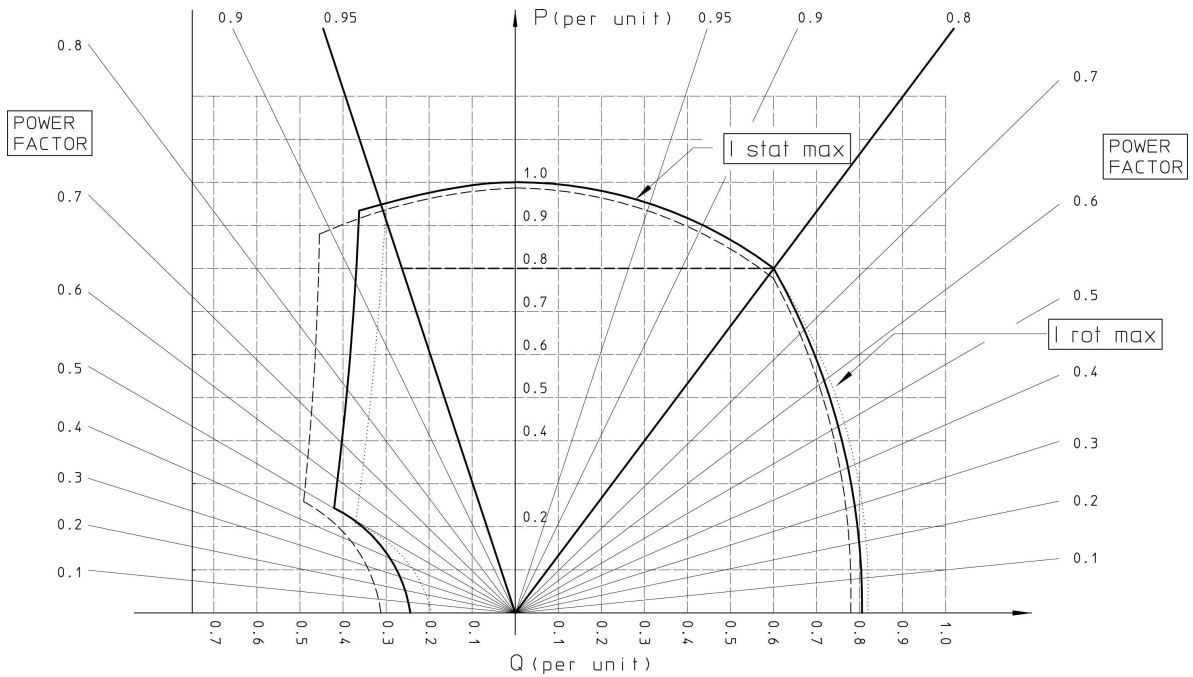

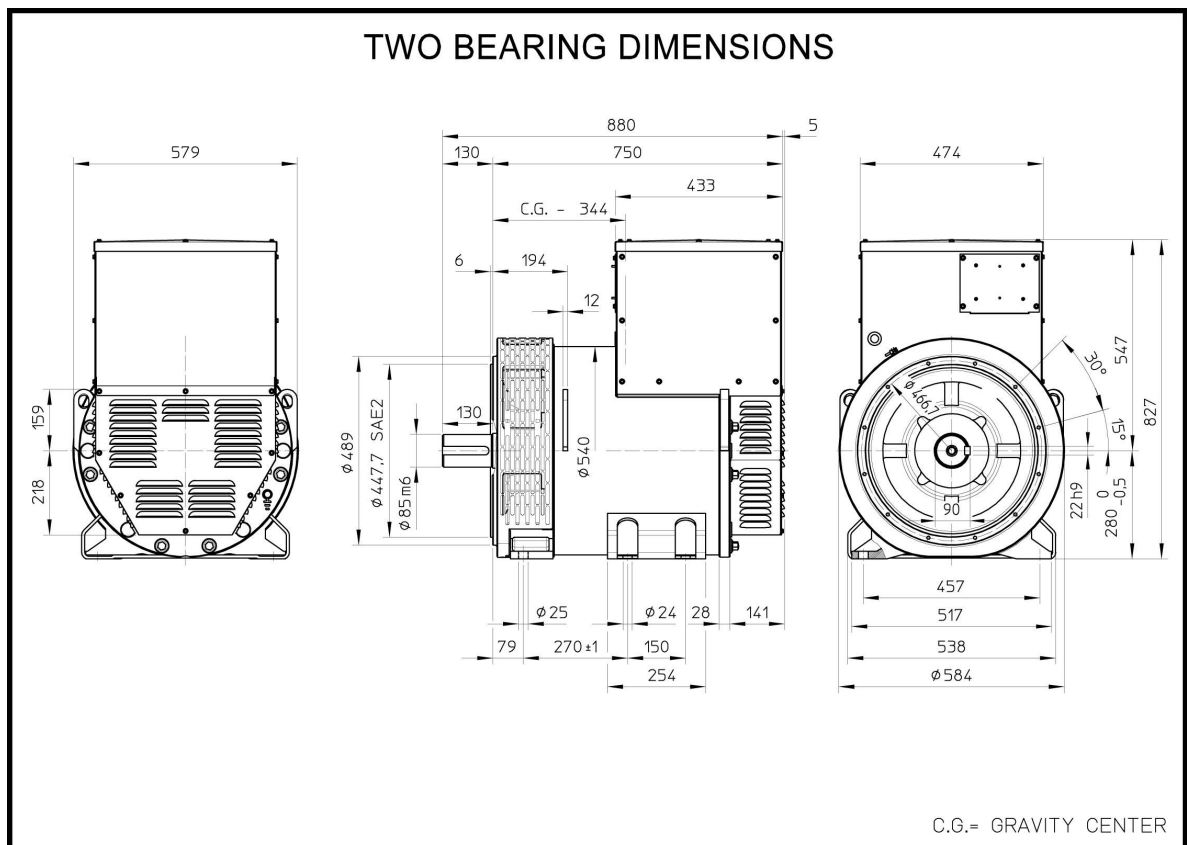
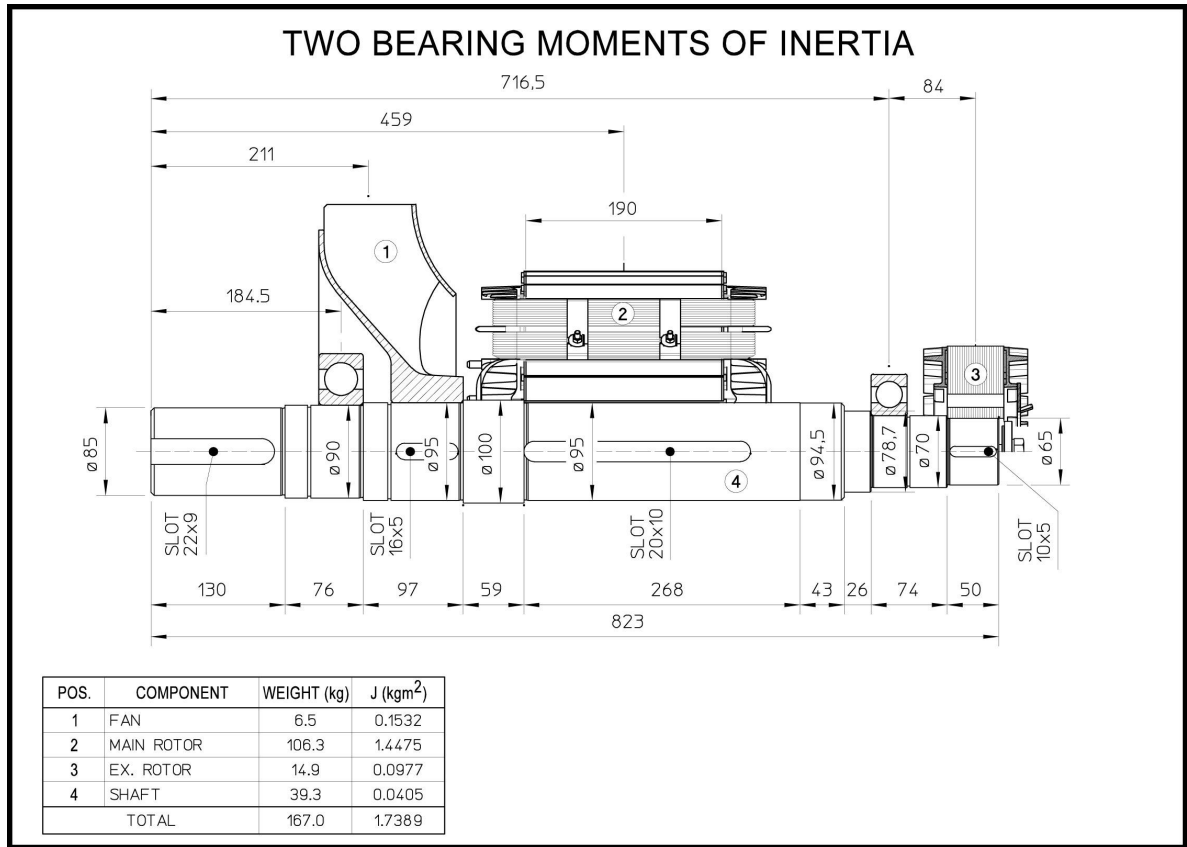

ECO38-1S/4 A

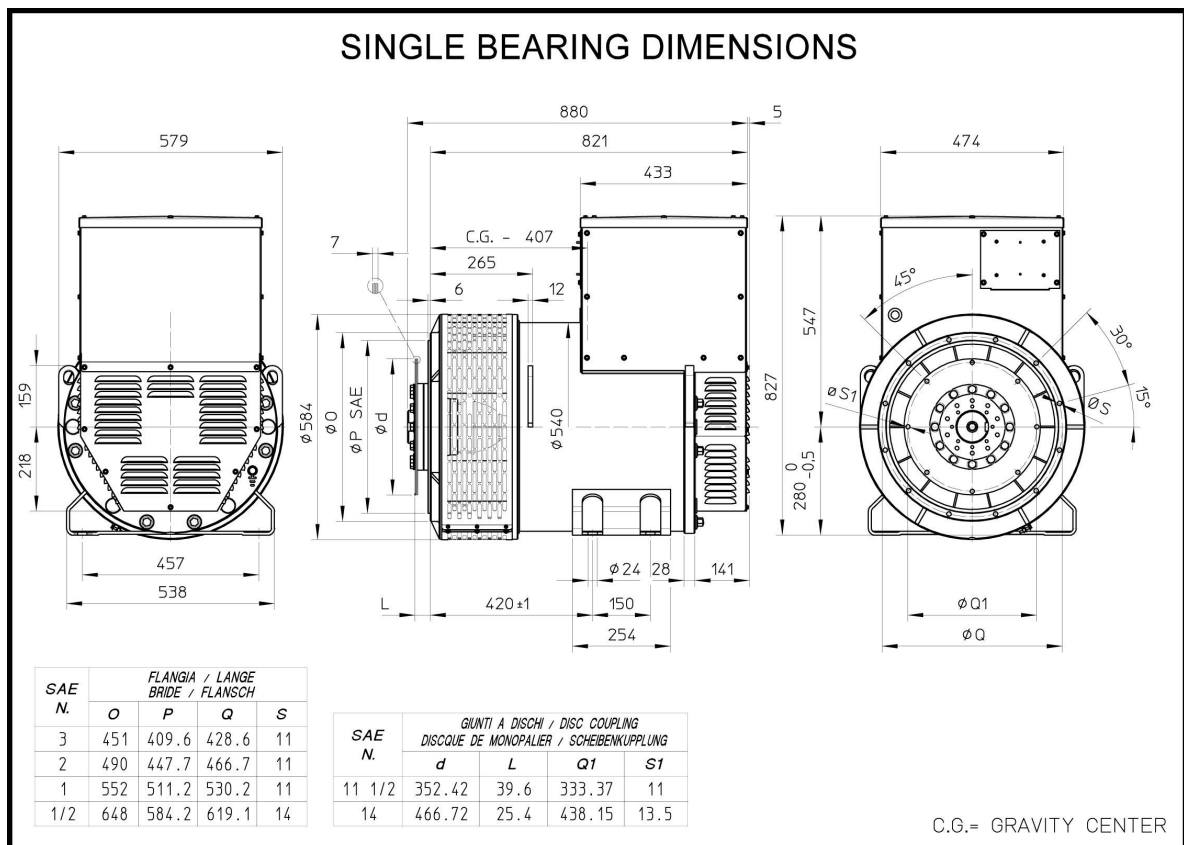
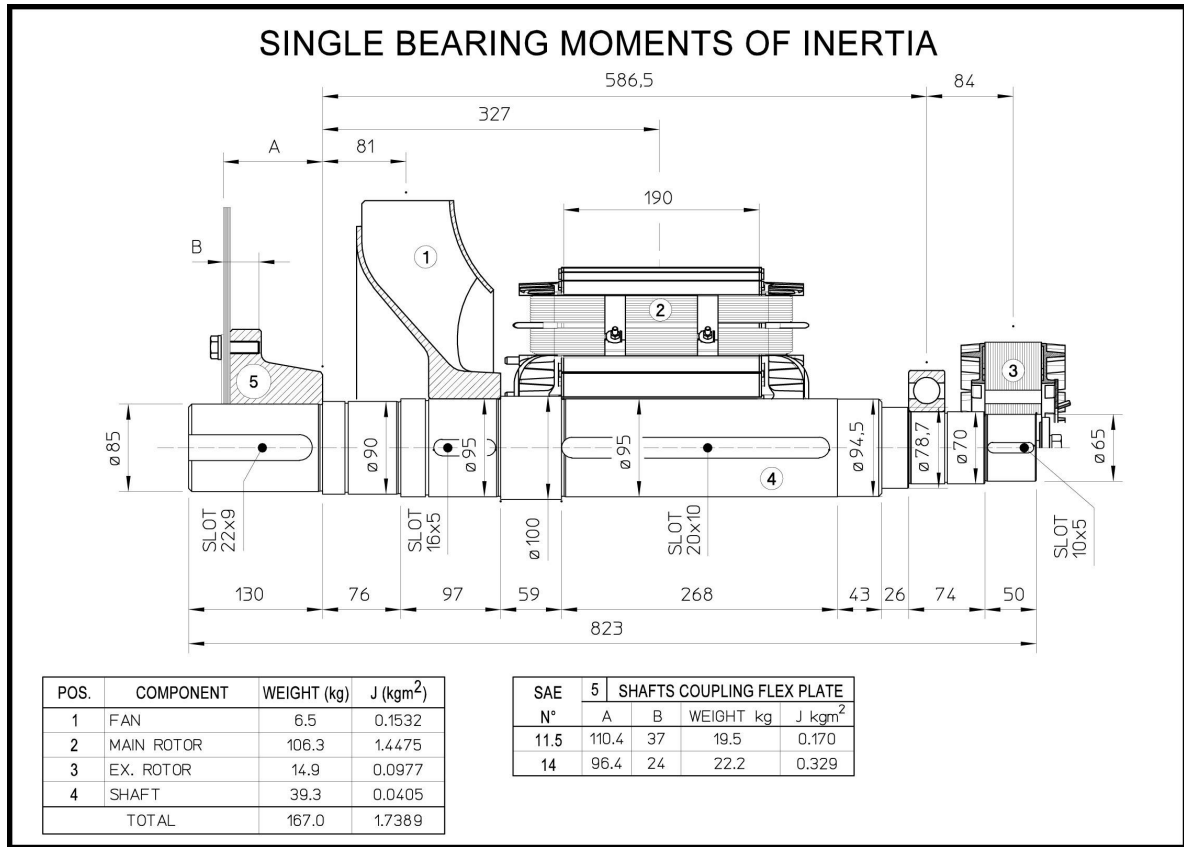

ECO38-2S/4 A

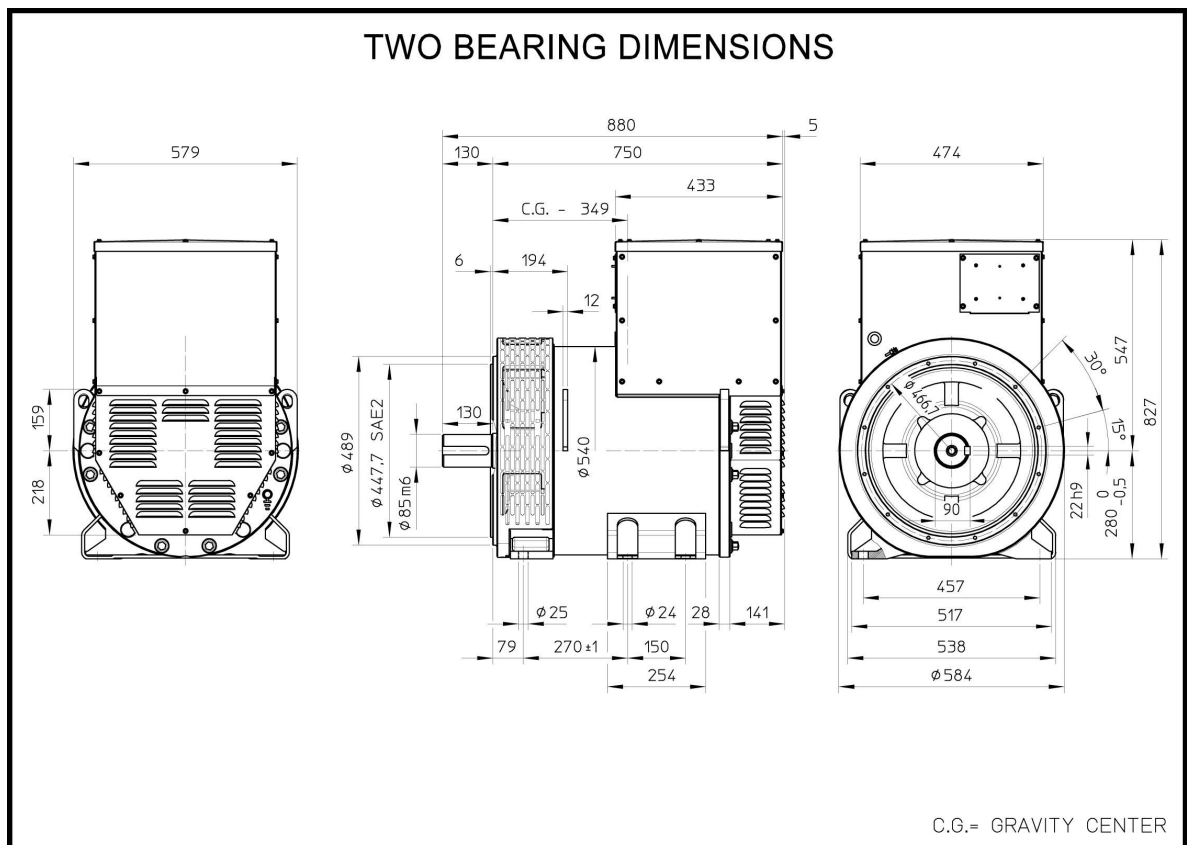
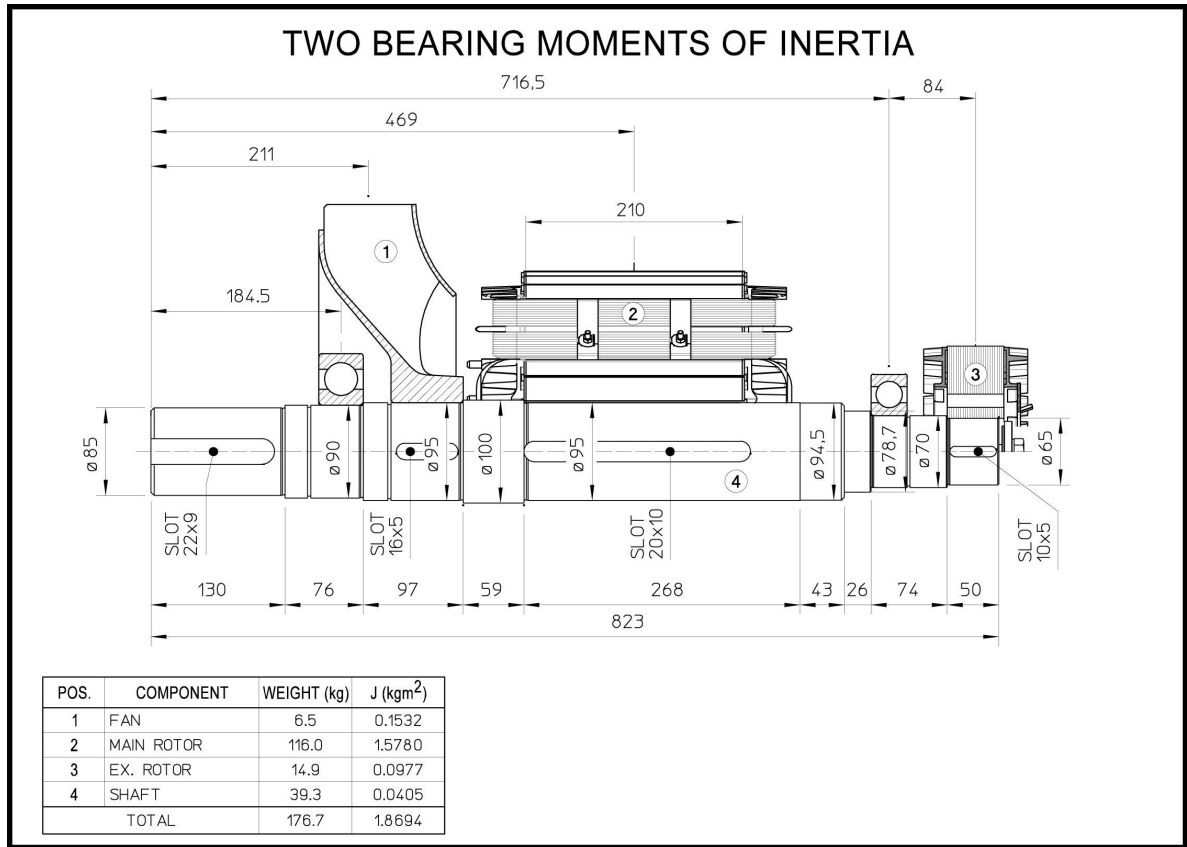

ECO38-2S/4 A

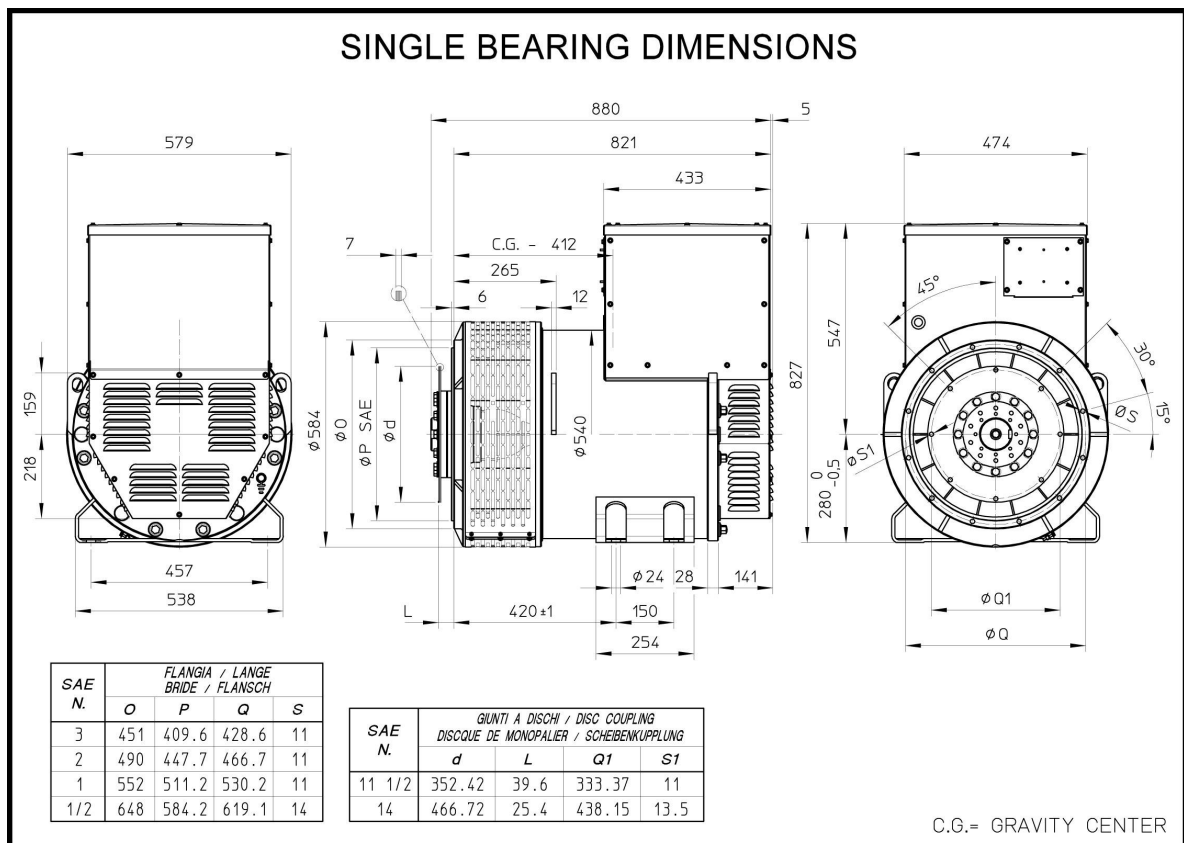
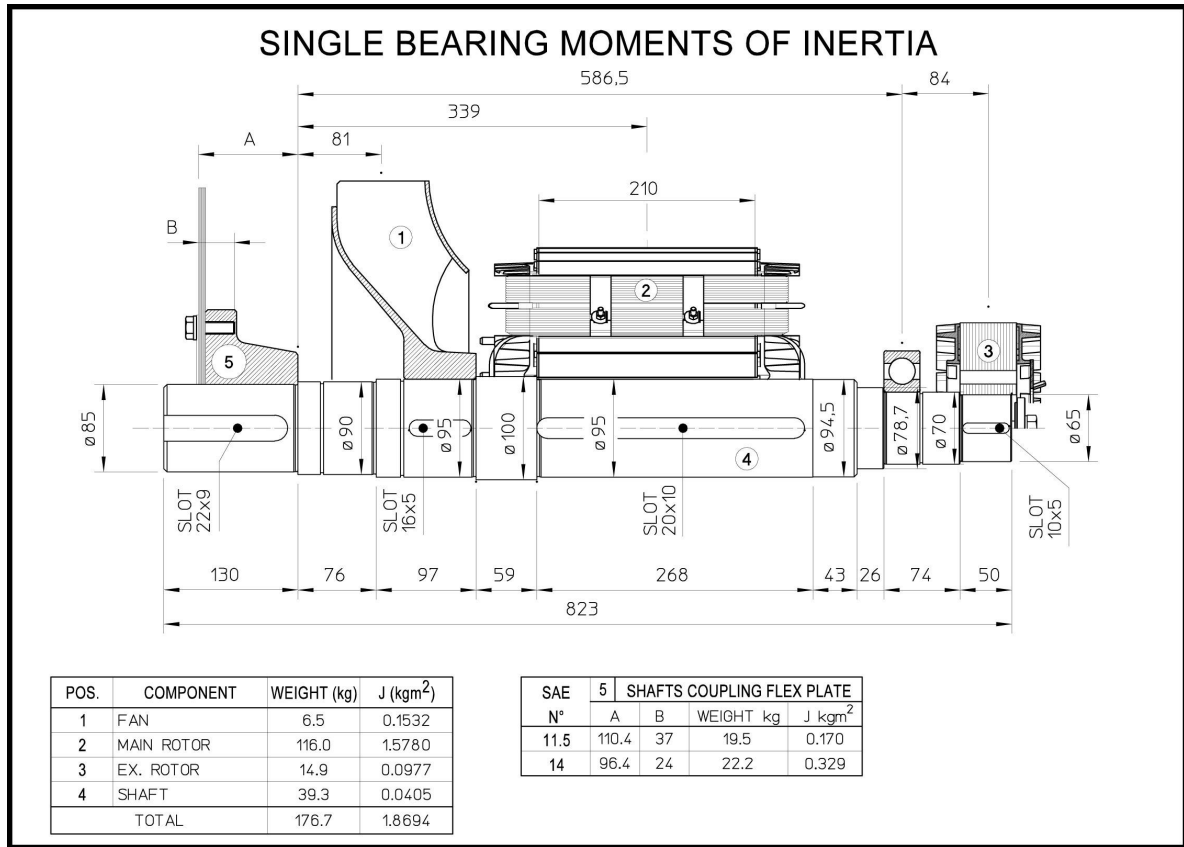

ECO38-3S/4 A

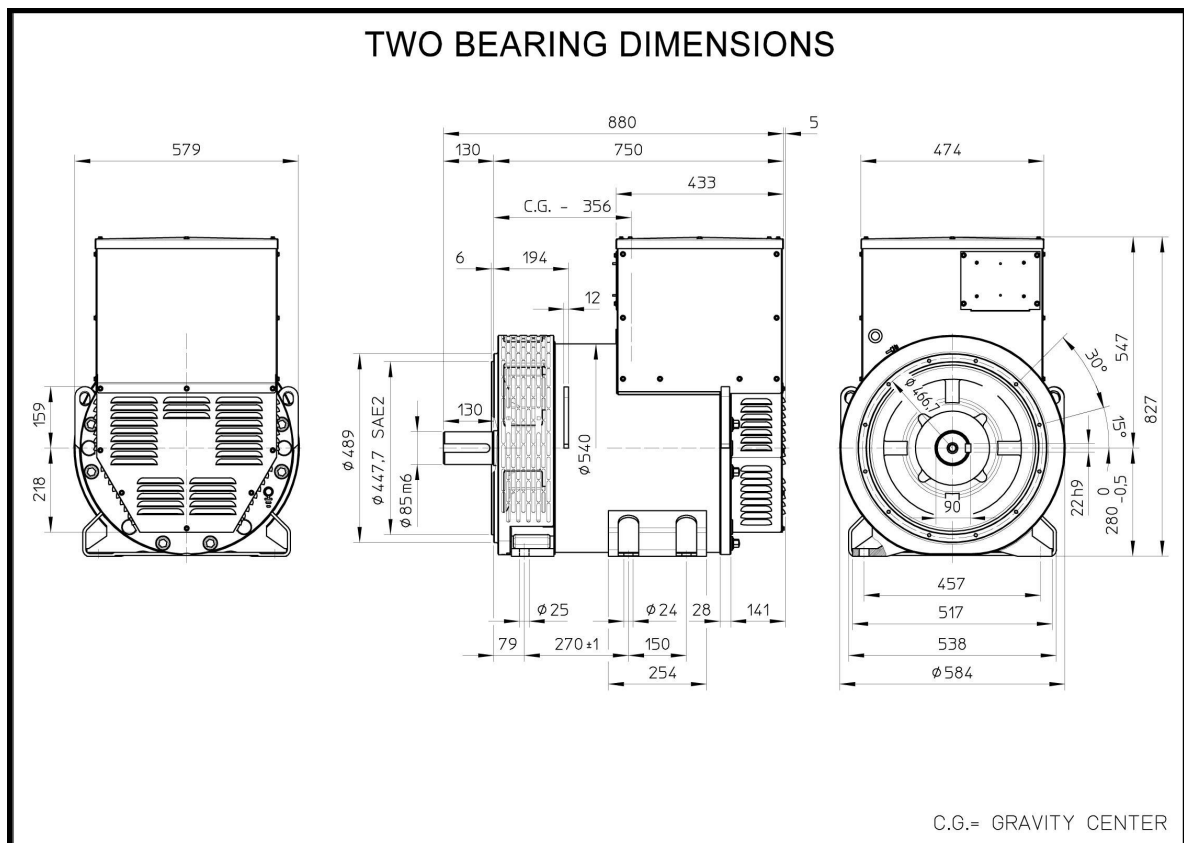
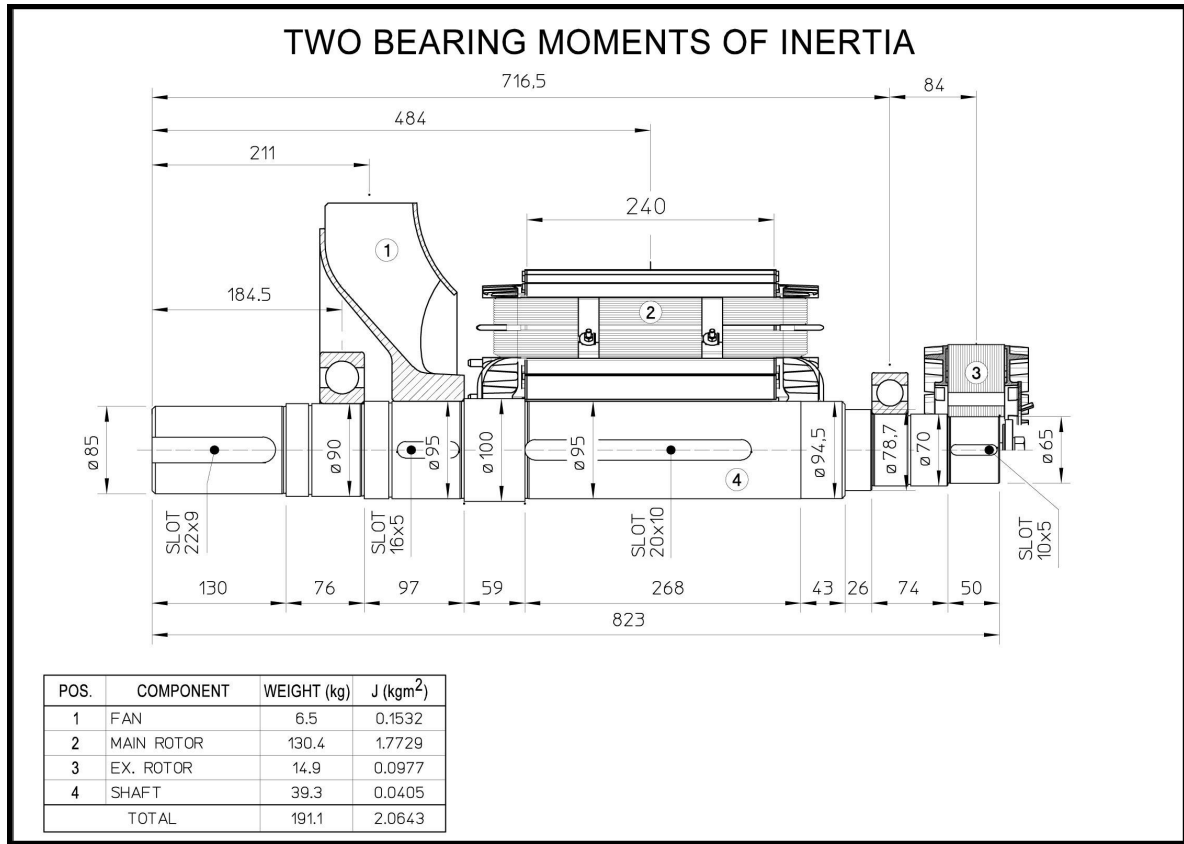

ECO38-3S/4 A

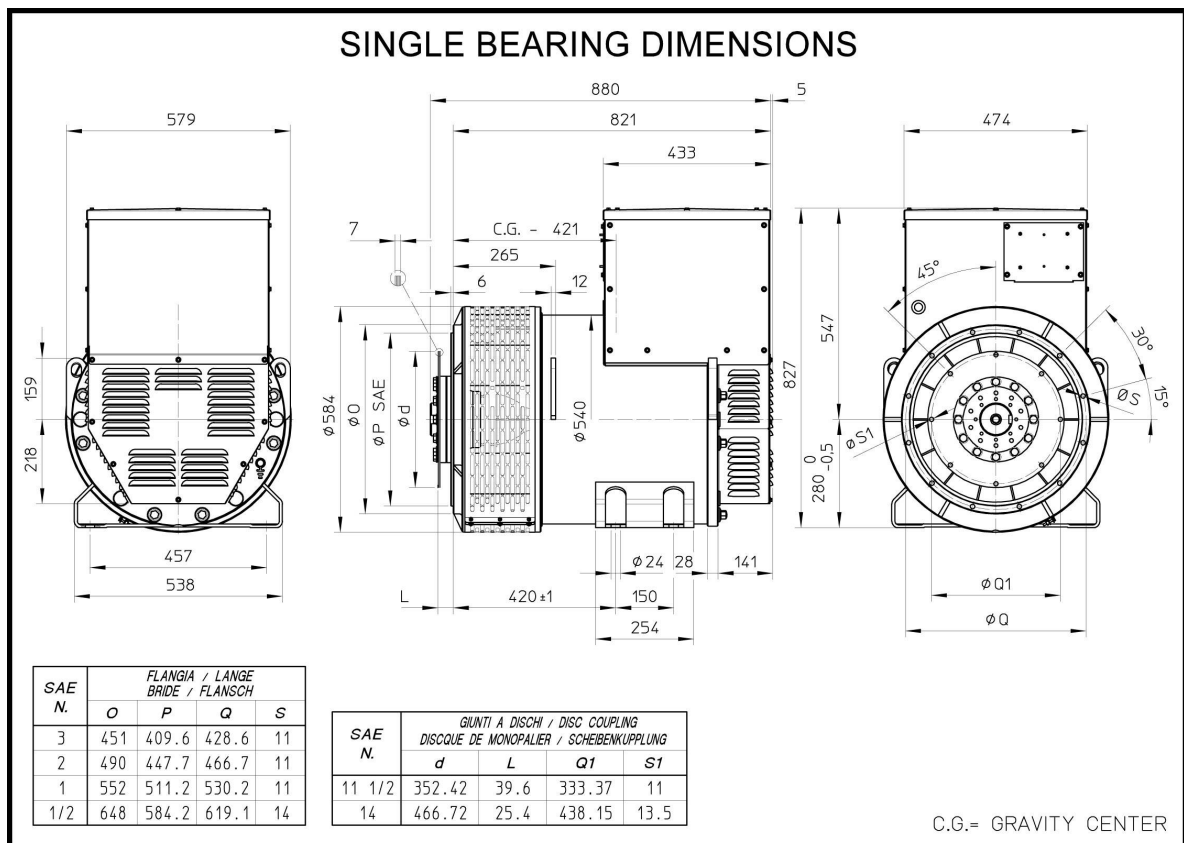
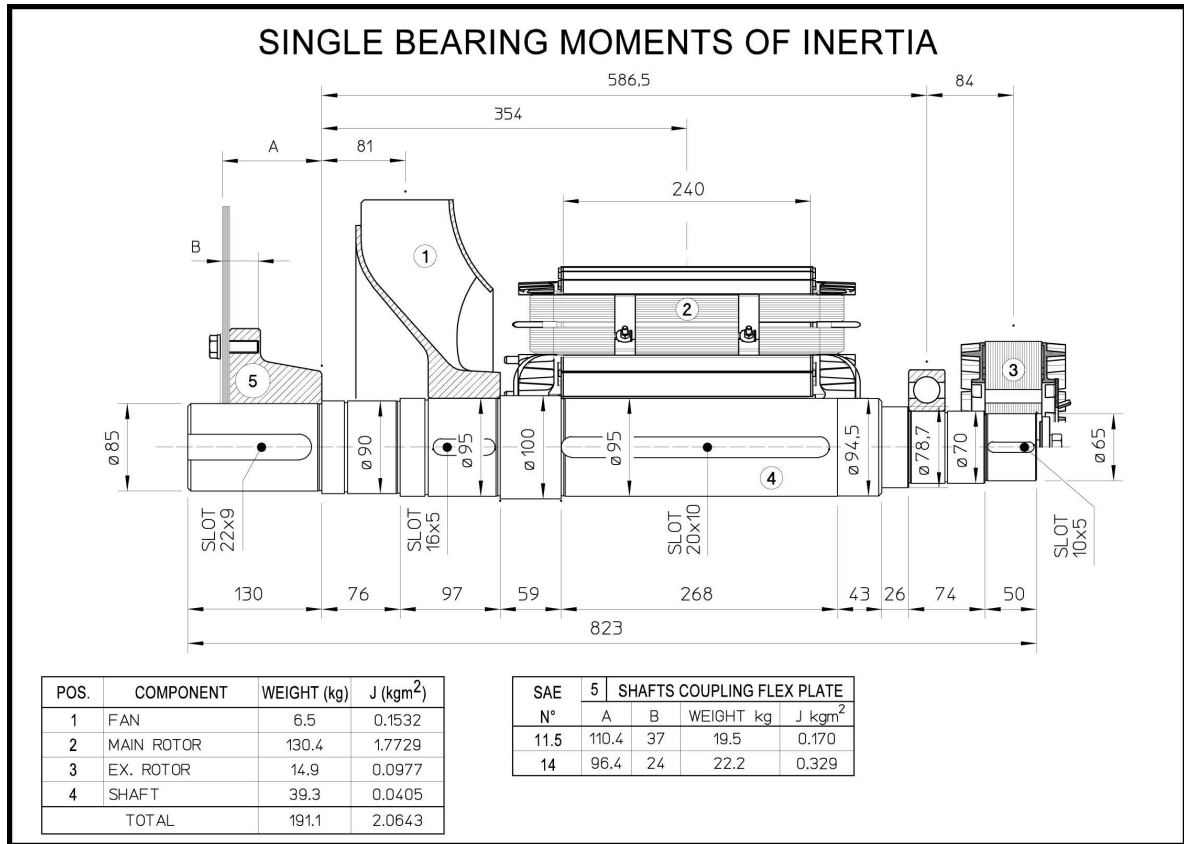

ECO38-1L/4 A

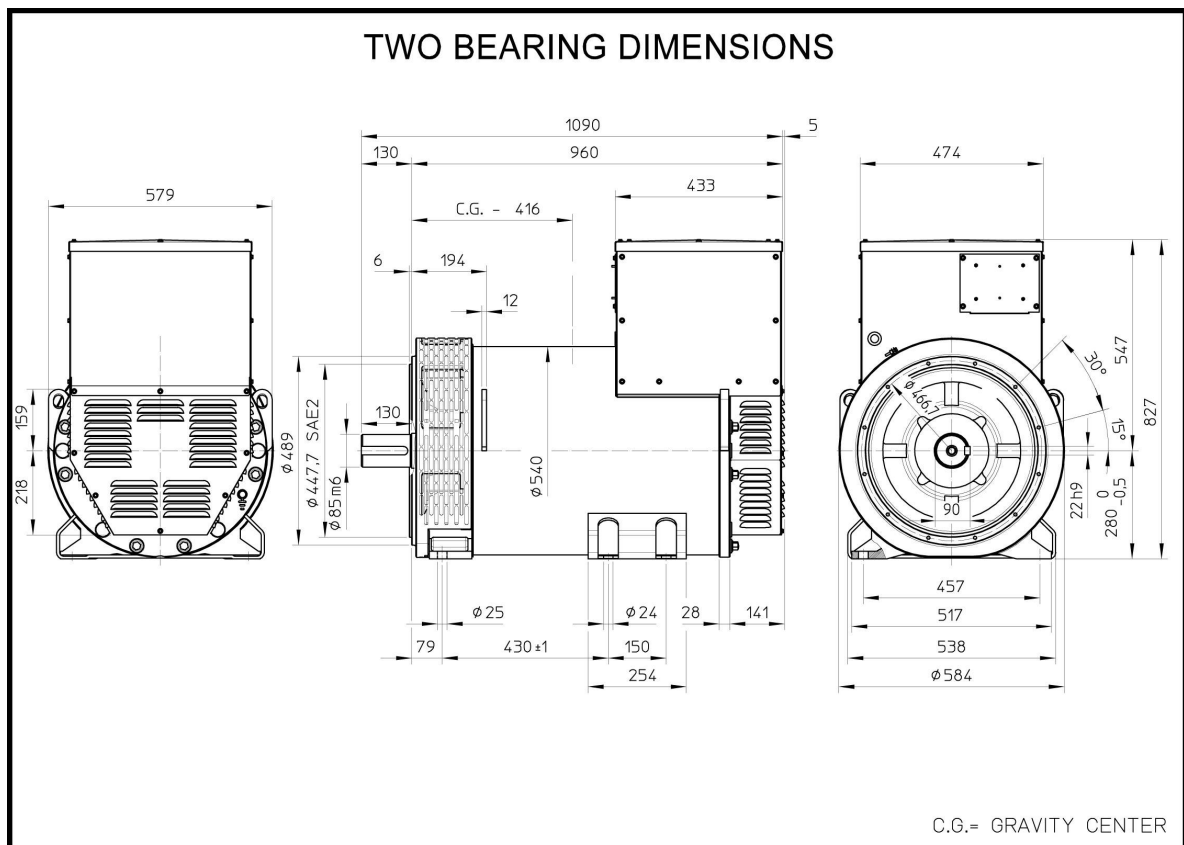
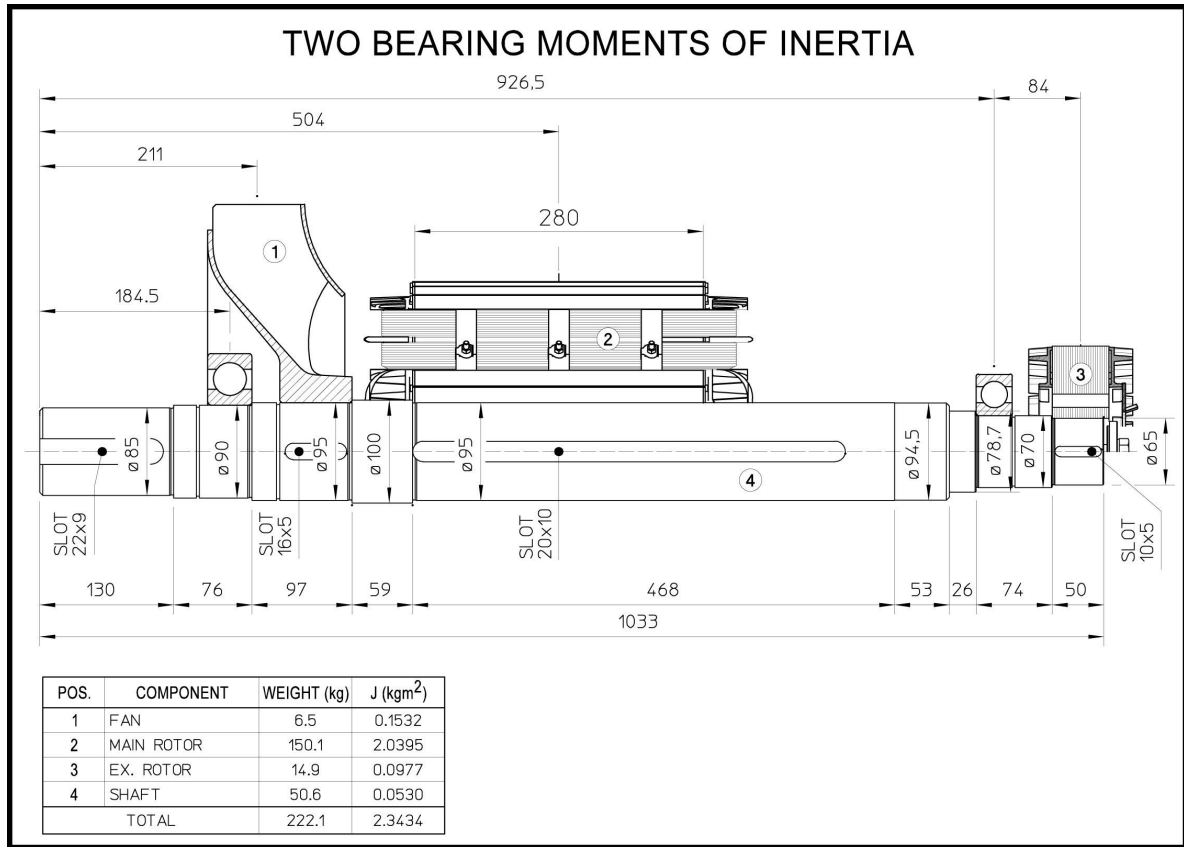

ECO38-1L/4 A

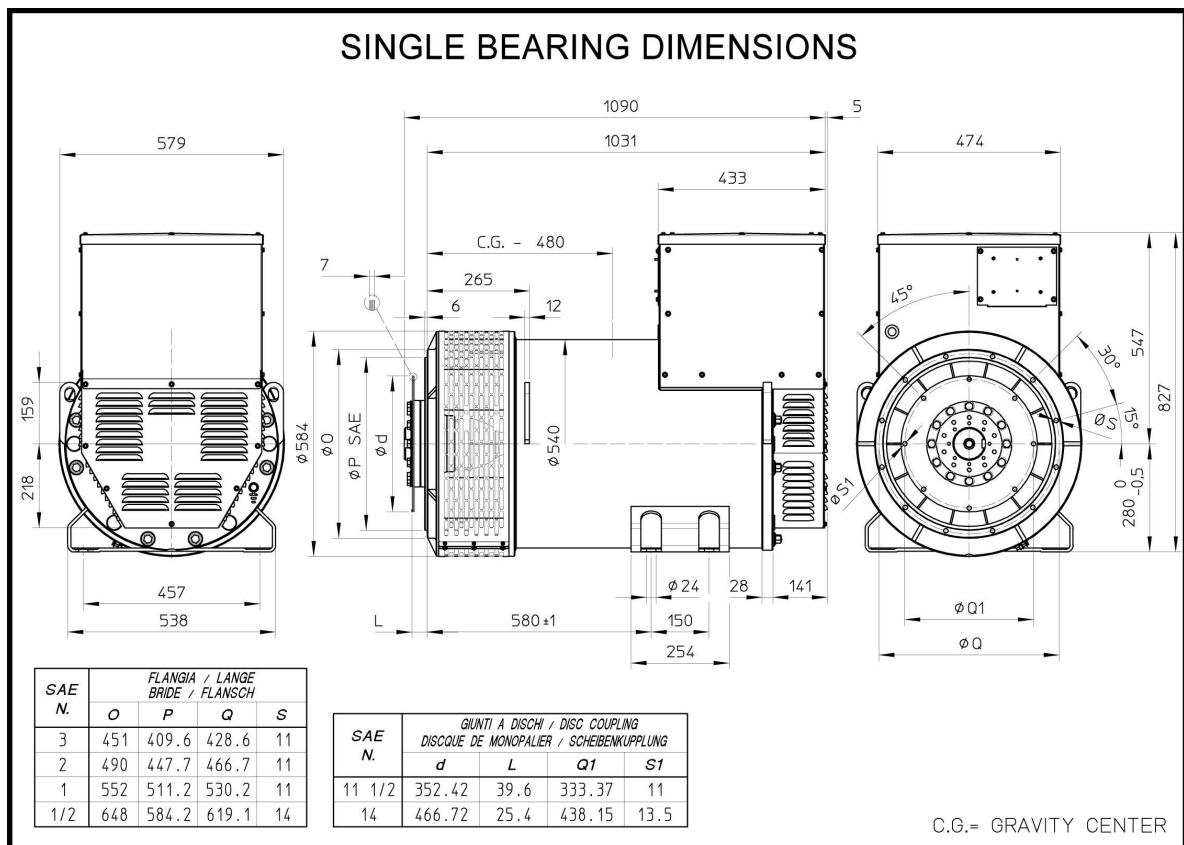
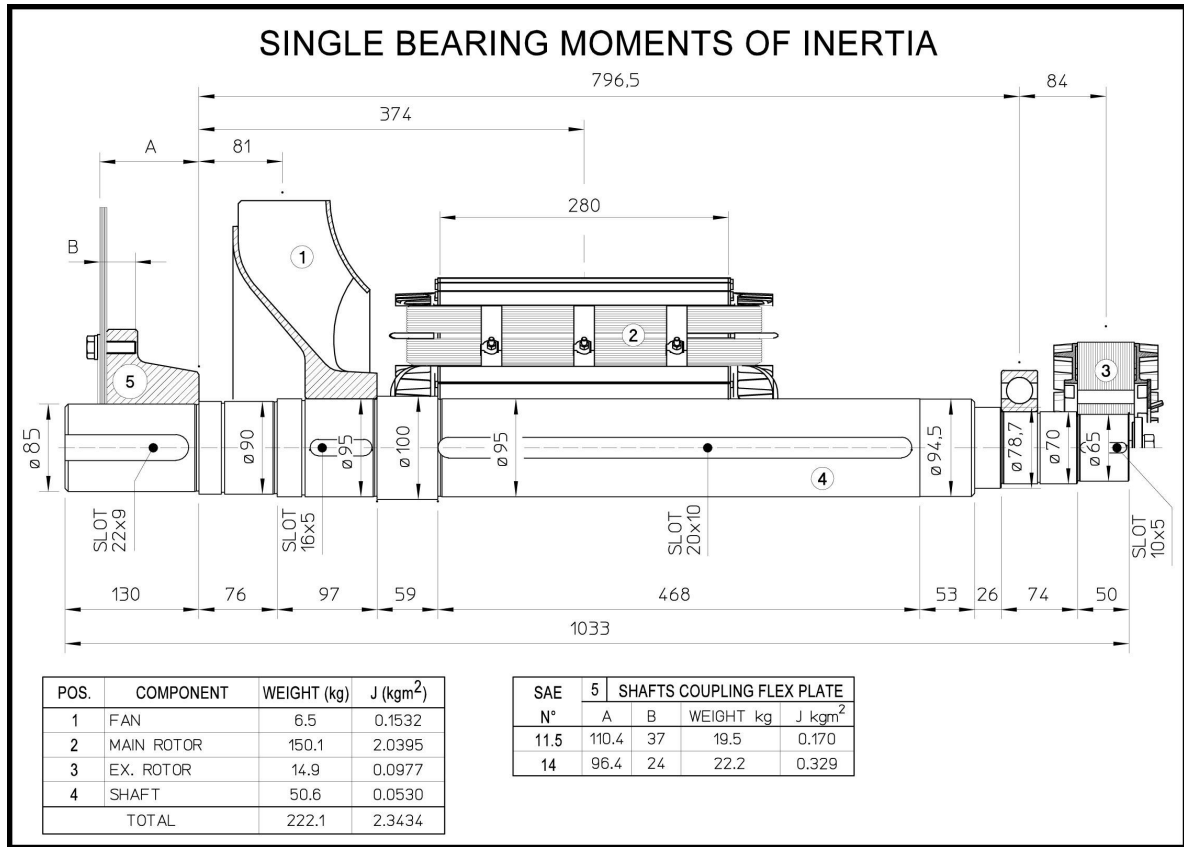

ECO38-2L/4 A

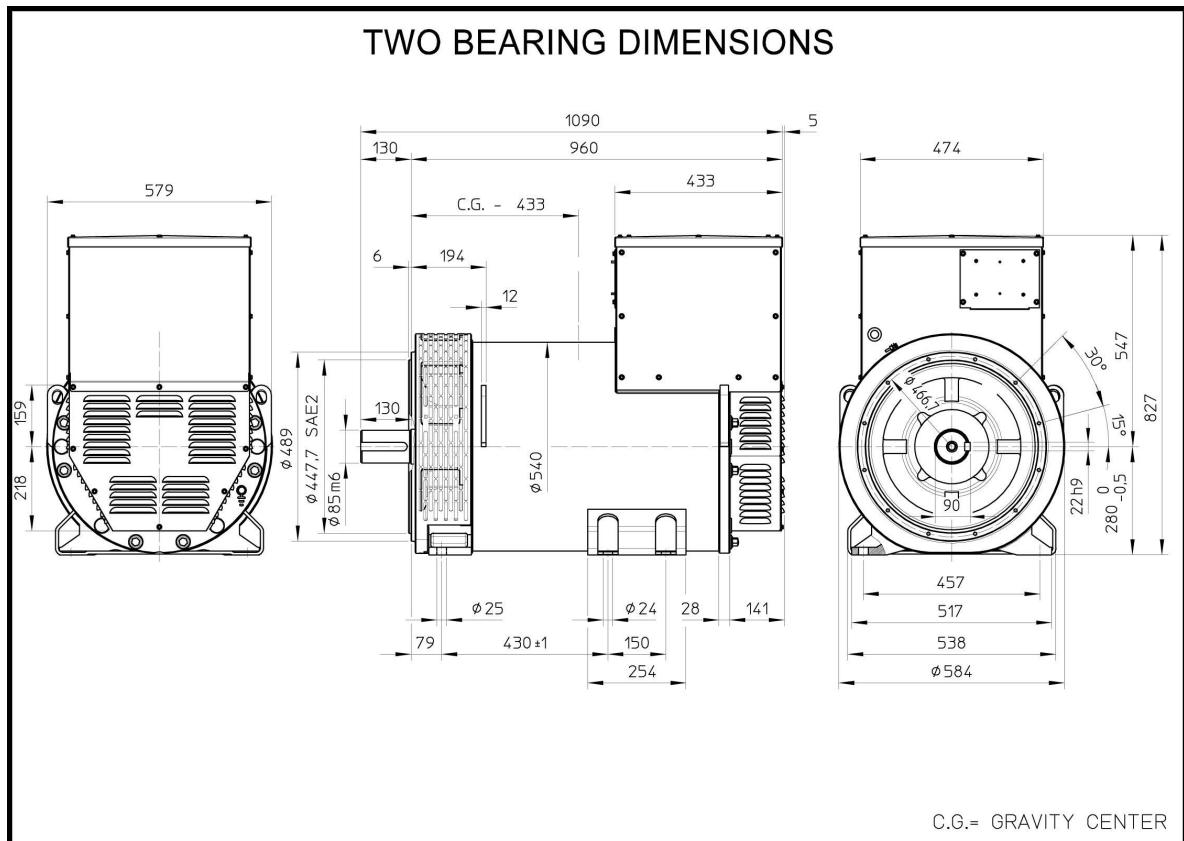
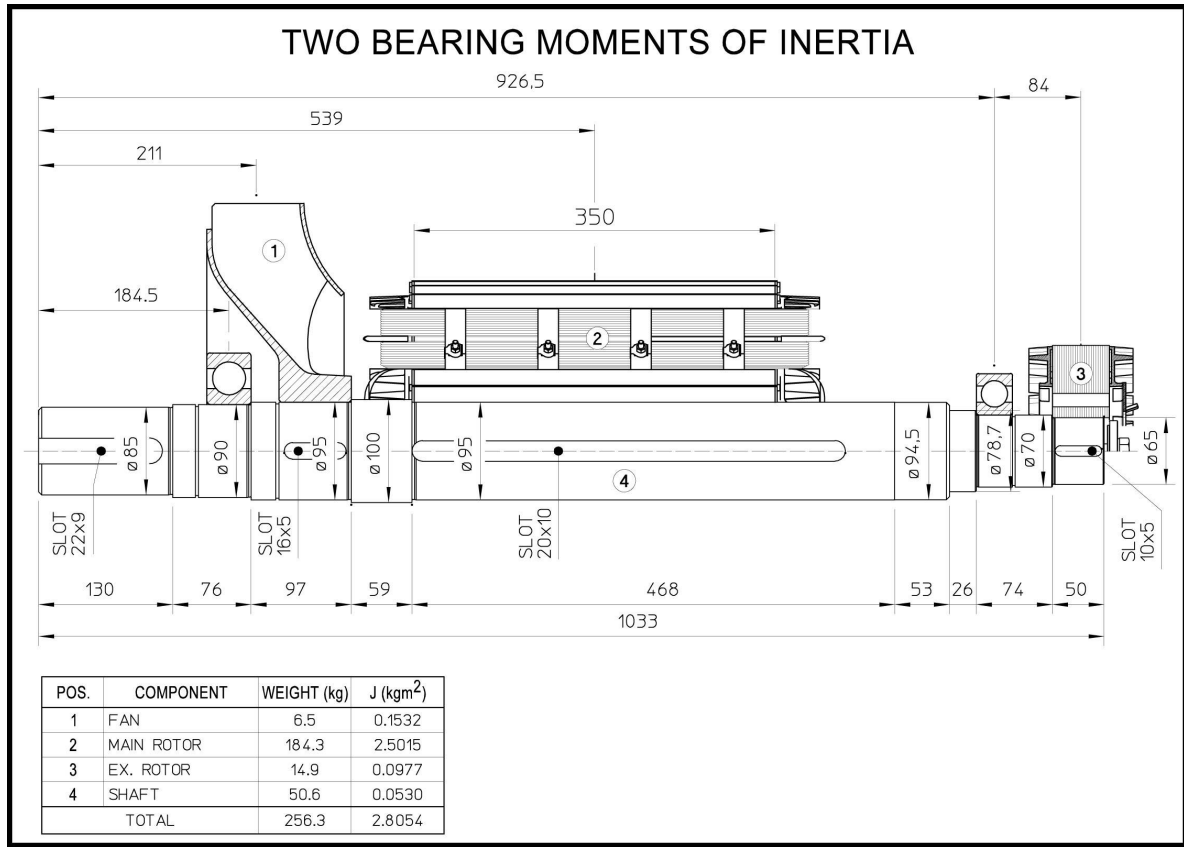

ECO38-2L/4 A

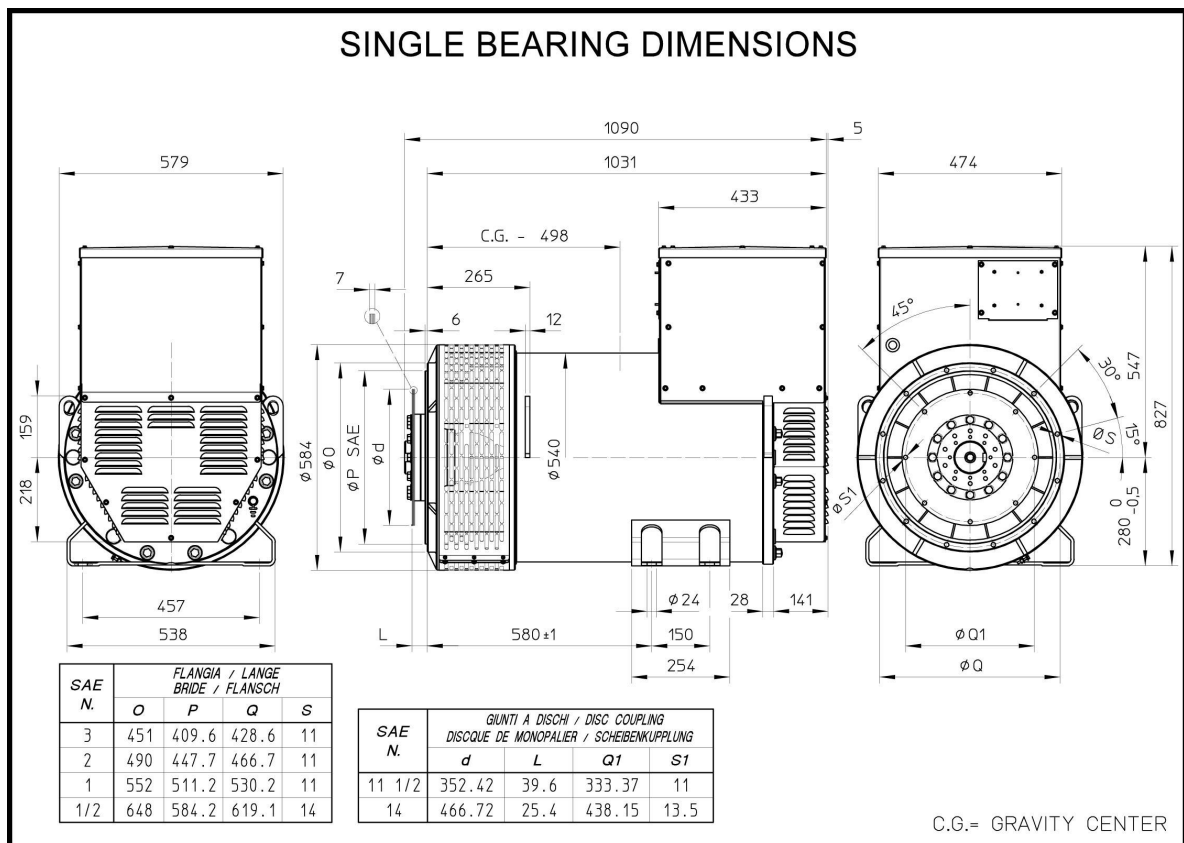
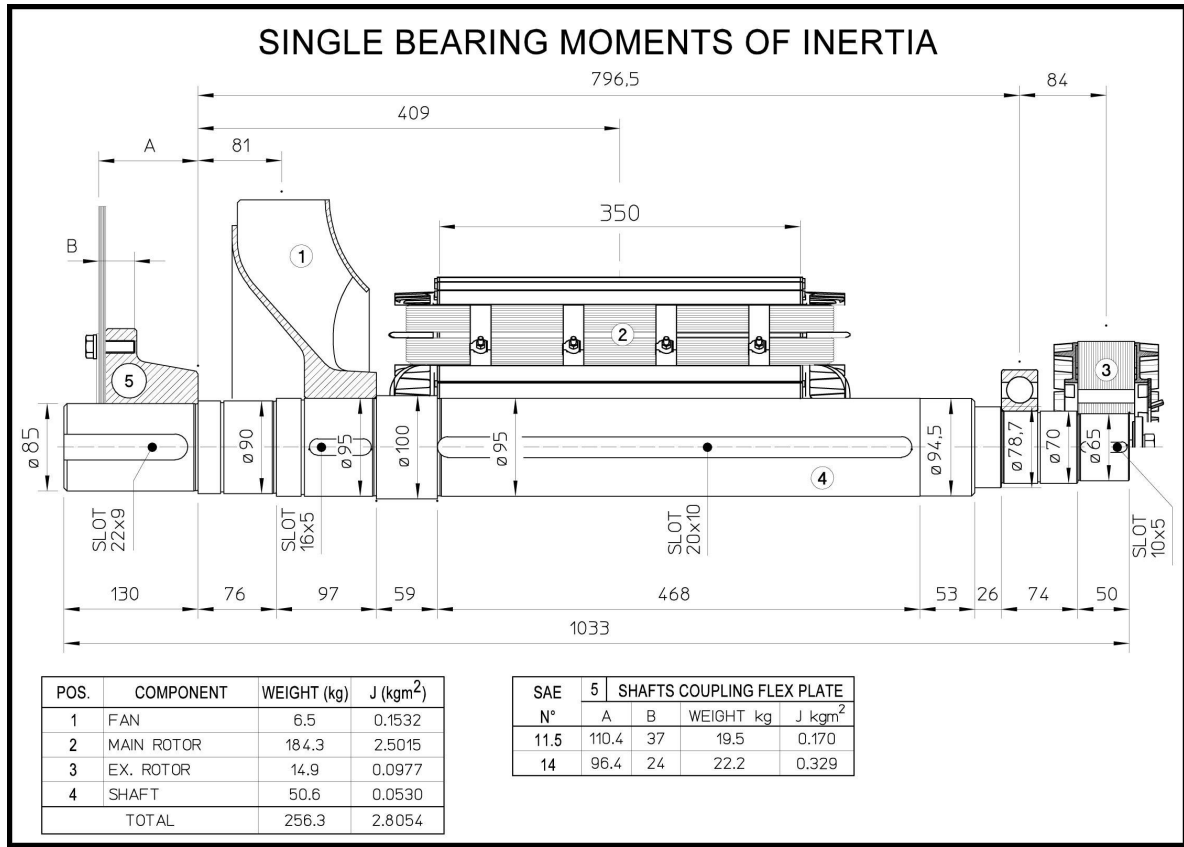

ECO38-3L/4 A

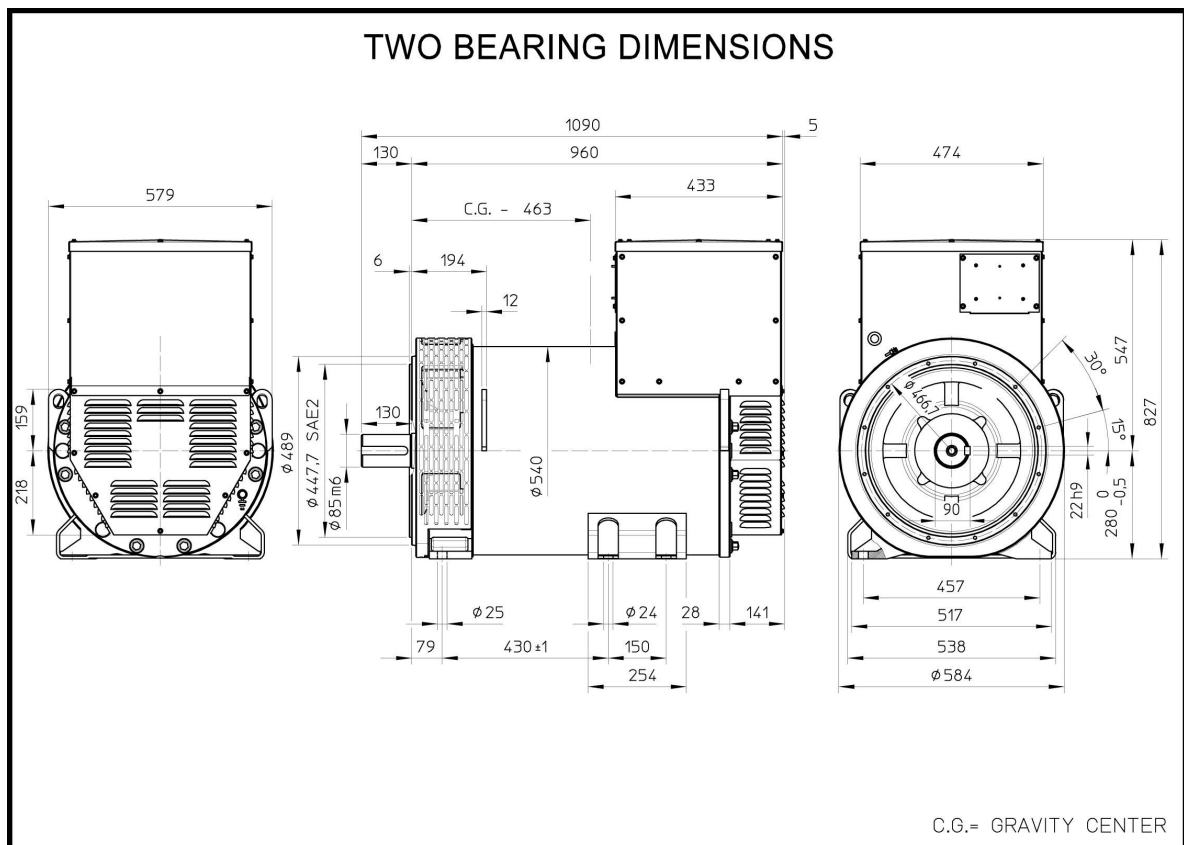
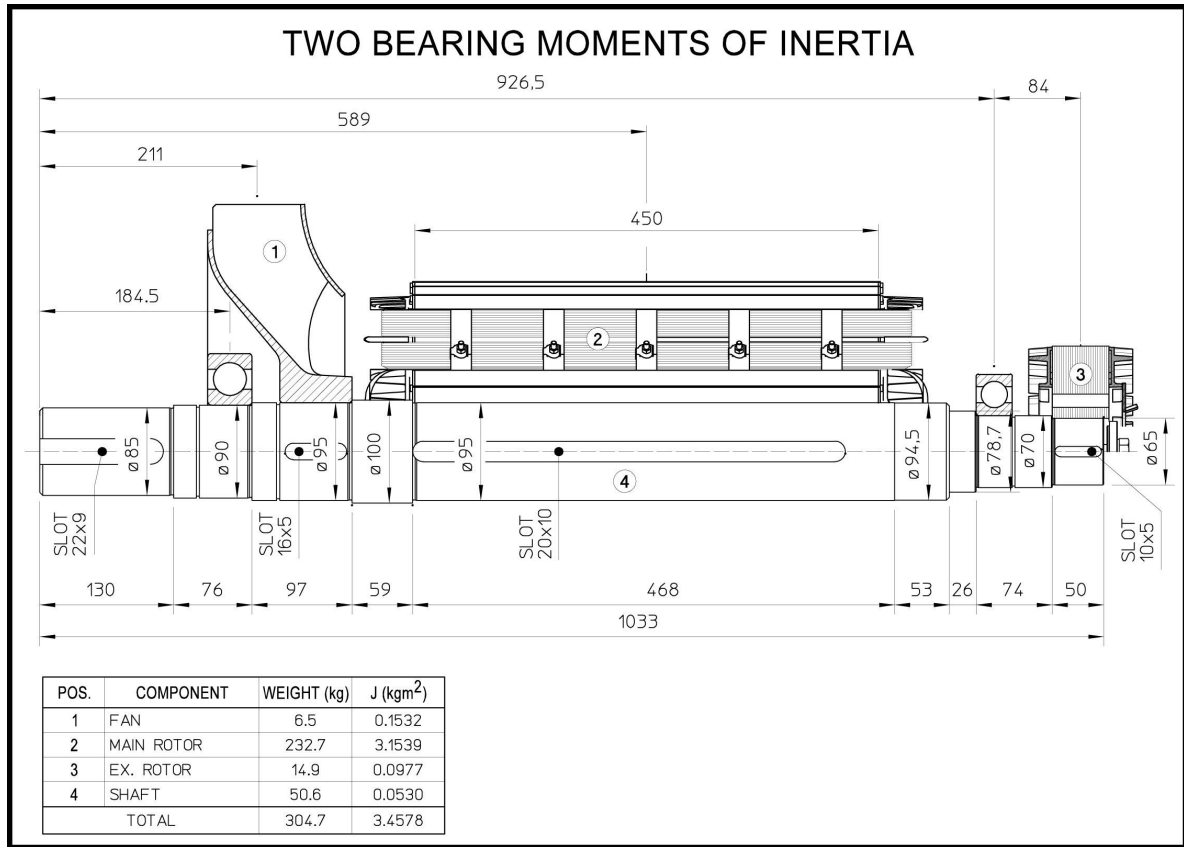

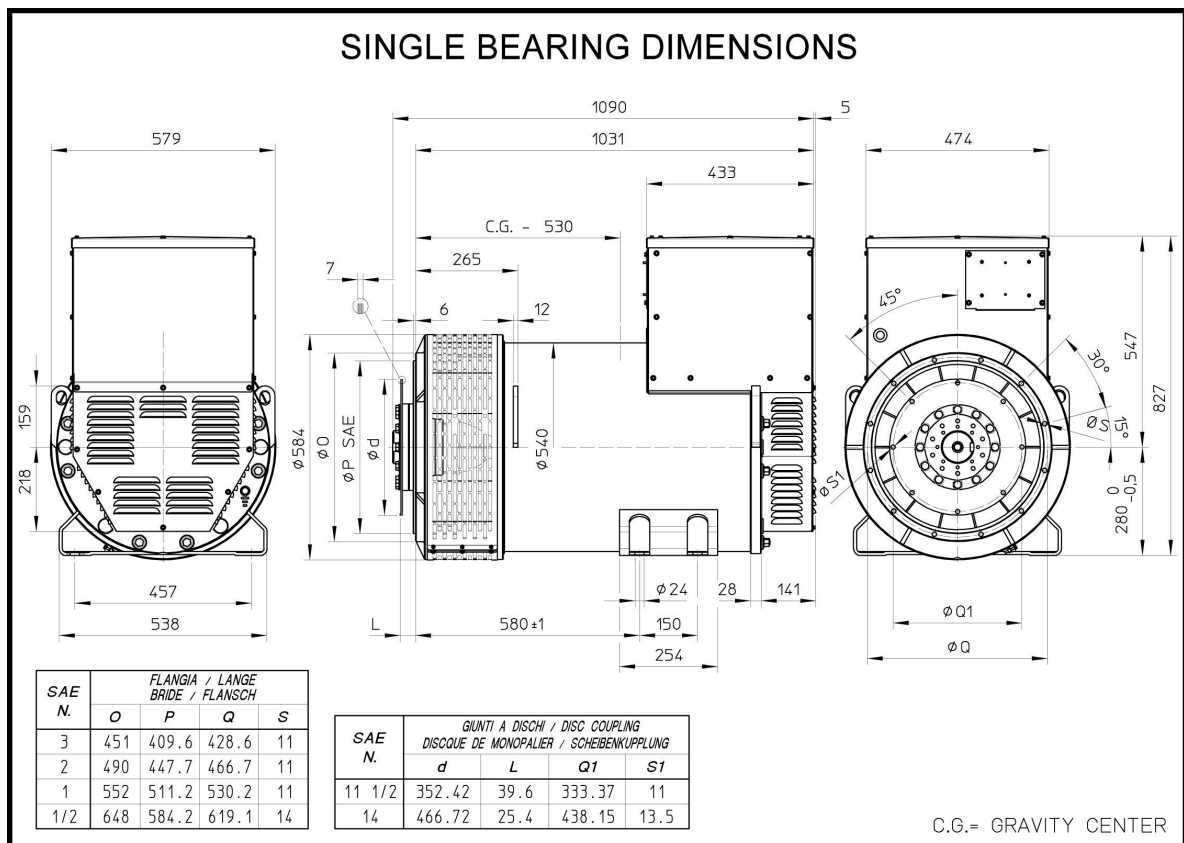
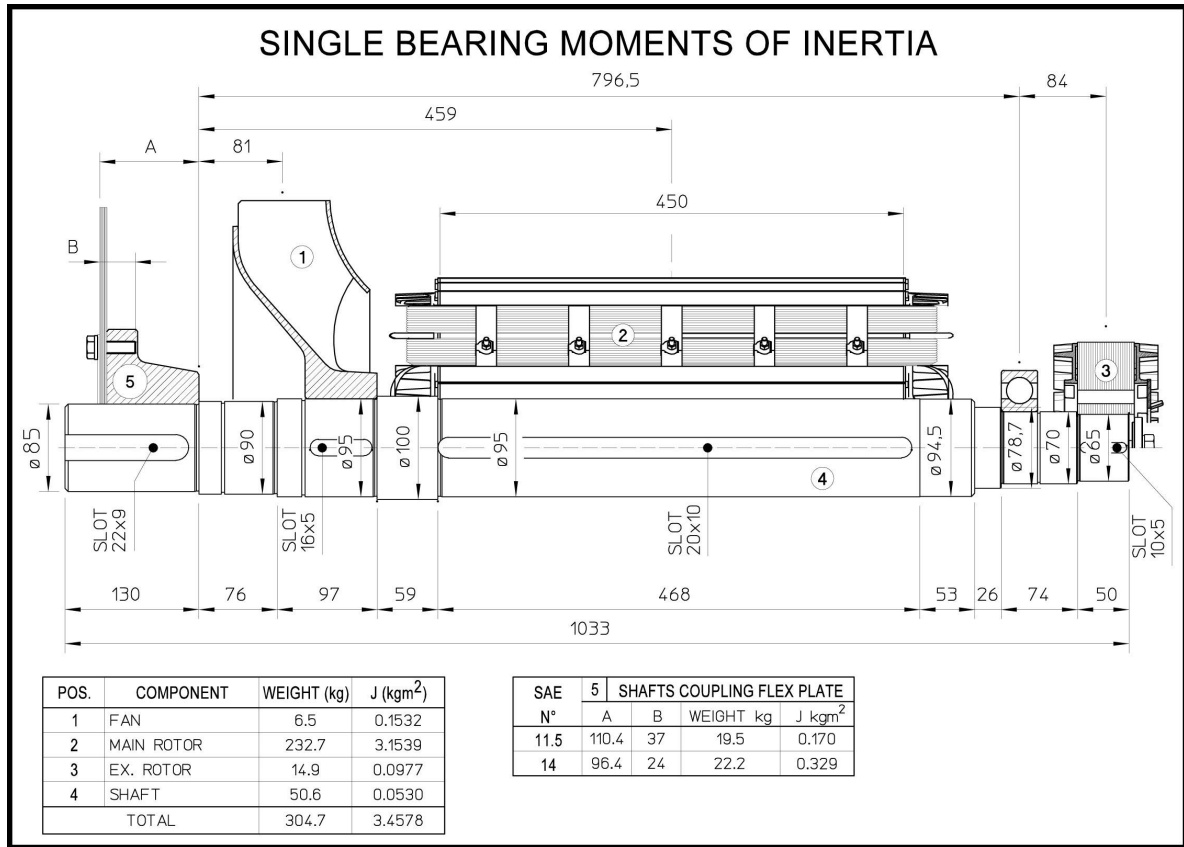

Mecc Alte SpA (HQ)

Via Roma
20 - 36051 Creazzo
Vicenza - ITALY
T: +39 0444 396111
F: +39 0444 396166
E: info@meccalte.it
aftersales@meccalte.it

Mecc Alte Portable

Via Roma
20 - 36051 Creazzo
Vicenza - ITALY
T: +39 0444 396111
F: +39 0444 396166
E: info@meccalte.it
aftersales@meccalte.it

Mecc Alte Power Products srl

Via Melaro
2 - 36075 Montecchio
Maggiore (VI) - ITALY
T: +39 0444 1831295
F: +39 0444 1831306
E: info@meccalte.it
aftersales@meccalte.it

Zanardi Alternatori srl

Via Dei Laghi
48/B - 36077 Altavilla
Vicenza - ITALY
T: +39 0444 370799
F: +39 0444 370330
E: info@zanardialternatori.it

United Kingdom

Mecc Alte U.K. LTD
6 Lands' End Way
Oakham
Rutland, LE15 6RF
T: +44 (0) 1572 771160
F: +44 (0) 1572 771161
E: info@meccalte.co.uk
aftersales@meccalte.co.uk

Spain

Mecc Alte España S.A.
C/ Rio Taibilla, 2
Polig. Ind. Los Valeros
03178 Benijofar (Alicante)
T: +34 (0) 96 6702152
F: +34 (0) 96 6700103
E: info@meccalte.es
aftersales@meccalte.es

China

Mecc Alte Alternator Haimen LTD
755 Nanhai East Rd
Jiangsu HEDZ 226100 PRC
T: +86 (0) 513 82325758
F: +86 (0) 513 82325768
E: info@meccalte.cn
aftersales@meccalte.cn

India

Mecc Alte India PVT LTD
Plot NO: 1, Sanaswadi
Talegaon
Dhamdhare Road Taluka:
Shirur, District:
Pune - 412208
Maharashtra, India
T: +91 2137 619600
F: +91 2137 619699
E: info@meccalte.in
aftersales@meccalte.in

U.S.A. and Canada

Mecc Alte Inc.
1229 Adams Drive
McHenry, IL, 60051
T: +1 815 344 0530
F: +1 815 344 0535
E: info@meccalte.us
aftersales@meccalte.us

Germany

Mecc Alte Generatoren GmbH
Ensener Weg 21
D-51149 Köln
T: +49 (0) 2203 503810
F: +49 (0) 2203 503796
E: info@meccalte.de
aftersales@meccalte.de

Australia

Mecc Alte Alternators PTY LTD
10 Duncan Road, PO Box 1046
Dry Creek, 5094, South
Australia
T: +61 (0) 8 8349 8422
F: +61 (0) 8 8349 8455
E: info@meccalte.com.au
aftersales@meccalte.com.au

France

Mecc Alte International S.A.
Z.E. La Gagnerie
16330 ST.Amant de Boixe
T: +33 (0) 545 397562
F: +33 (0) 545 398820
E: info@meccalte.fr
aftersales@meccalte.fr

Far East

Mecc Alte (F.E.) PTE LTD
19 Kian Teck Drive
Singapore 628836
T: +65 62 657122
F: +65 62 653991
E: info@meccalte.com.sg
aftersales@meccalte.com.sg



www.meccalte.com